



КАТАЛОГ ПРОДУКЦИИ
PRODUCT CATALOG



Испанская производственная компания «MSM» имеет успешный опыт деятельности на мировом рынке дверной фурнитуры и замков с 1965 г., а начиная с 2000 года, мы, ООО «МСМ» представляем ее на рынке России. Торговая марка «MSM» на территории России запатентована.

На сегодняшний день компания входит в число лидеров производящих дверную фурнитуру. Вся продукция производимая под брендом «MSM» имеет высокое качество и современный дизайн, отвечающий международным стандартам. За все время работы мы зарекомендовали себя, как профессионального, ответственного и надежного поставщика.

Ассортимент продукции MSM включает в себя полный перечень изделий, необходимых для комплектации дверей:

- ◆ Дизайнерские ручки нескольких коллекций;
- ◆ Фиксаторы для ручек и накладки для цилиндрических механизмов;
- ◆ Цилиндрические механизмы;
- ◆ Врезные замки и защелки для межкомнатных дверей;
- ◆ Врезные замки и ручки для стальных дверей;
- ◆ Накладные замки;
- ◆ Дверные петли;
- ◆ Ручки скобы, дверные молоточки;
- ◆ Доводчики;
- ◆ Навесные замки. Почтовые и мебельные замочки;
- ◆ Стопоры, глазки и ригели;
- ◆ Универсальные ручки со встроенным механизмом запирания.

Также компания «MSM» производит дверную фурнитуру под брендом «DAMX». Преимущество этой марки - это соотношение цены и качества.

Эта продукция представляет собой дверную фурнитуру эконом класса. При сравнительно низкой стоимости нам удалось сохранить и качество и высокие эксплуатационные свойства.

Большое значение мы придаем качественной упаковке, что обеспечивает сохранность товара при транспортных перевозках и погрузочно-разгрузочных работах, а также привлекает Покупателей.

Для нашей компании важно развитие и укрепление отношений с каждым клиентом. Мы работаем как с частными лицами, небольшими компаниями, так и с крупными организациями. Розничные цены указаны на сайте. Для постоянных клиентов, конечно, у нас есть оптовые цены, также у нас действует система скидок для оптовых постоянных клиентов.

Наши цели:

- ◆ Контроль товарного запаса, для постоянного наличия на складе.
- ◆ Контроль изготовления товара, для поддержания его высокого уровня качества.
- ◆ Расширение ассортимента (в том числе по предложениям наших партнеров, клиентов)
- ◆ Сохранение высокого уровня обслуживания.
- ◆ Совершенствование технологий.

Надеемся увидеть Вас в числе наших Партнеров.

Industrial Trading Company - MSM - has a successful experience of produce and marketing door locks and handles, and door accessories since 1965.

Today we are one of the world famous companies making door accessories. All production made under MSM brand , has high quality and the modern design meeting the international ISO-9001 standards.

For long time we proved, as the professional, responsible, reliable and continuously developing leader in the field.

The production range of MSM includes the full range of the products which necessary for a complete set of interroom doors, and also accessories and locks for metal entrance doors:

- ◆ Designing handles of several collections;
- ◆ Locks and latches for interroom doors;
- ◆ Handles and locks for entrance doors;
- ◆ Rim lock;
- ◆ Door hinges;
- ◆ Pull handles and door knockers;
- ◆ Cylinder mechanisms;
- ◆ Door closers;
- ◆ Pad locks, zip locks and furniture locks;
- ◆ Handle latches with the built-in mechanism of locking.

Also we make door accessories under DAMX brand. Advantage of this brand - a ratio of the price and quality.

This product is an economy class door hardware. At a relatively low cost, we managed to maintain both the quality and high performance properties.

We always focus on the high-quality of our products packaging, which ensures the safety of the goods during transport, loading and unloading operations, and also attracts Customers.

Development and strengthening of the relations with each client is important for our company. We work as with individuals, the small companies and with the large organizations. Retail prices are specified on the site. For regular customers of course we have a wholesale prices, also we have a discounts system for wholesale regular customers.

Our goal:

- ◆ Control the goods stock to support our customers.
- ◆ Control the goods quality to keep our high quality level.
- ◆ Expansion of the range (according to proposals of our partners, clients)
- ◆ Keep our high level of service.
- ◆ Improvement of technologies.

We hope to see you among our Customers.

	Страница (Page)
Ручки и накладки дверные, на круглой накладке Round plate handles	
• Серия (Serie) «С»	6
• Серия (Serie) «D», «E», «K»	7
• Серия (Serie) «N»	10
• Серия (Serie) «R»	16
• DAMX серия (Serie) «W»	26
• DAMX серия (Serie) «R»	27
Ручки и накладки дверные, на квадратной накладке Square plate handles	
• Серия (Serie) «U»	32
• Серия (Serie) «A»	34
• Серия (Serie) «S»	37
Ручки на планке. Plate door handle	
• с узором, под цилиндр (межосевое 85 мм) Decorative, For lock size 85mm	38
• под цилиндр, межосевое (For lock size) 85 мм	40
• под сувальдный ключ (Safe lock)	48
• под цилиндр, межосевое (Mortise lock, size) 55 мм	49
• под цилиндр, межосевое (Mortise lock, size) 62 мм	50
• сантехнические и межкомнатные (Bathroom and interior door handles)	51
Ручки на планке DAMX под цилиндр. Plate door handle DAMX	
• межосевое (For lock size) 55 мм	53
• межосевое (For lock size) 62 мм	55
• межосевое (For lock size) 85 мм	56
Стяжки для крепления ручек на круглой накладке. Квадраты	60
Tie-screws for round plate handles. Spindles	
Ручки защелки дверные. Latch door handles	
• фалевые (Lever handle)	61
• шариковые (Ball handle)	65
• DAMX шариковые (Ball handle DAMX)	67
Ручки скобы. Pull handles	
• литые на круглой накладке, ЦАМ (Zink)	68
• нержавеющая сталь (stainless steel)	73
Механизмы врезные. Door latch	
• механические (mechanical)	77
• магнитные (magnetic)	80
Замки. Lock body	
• магнитные (magnetic)	81
• механические (mechanical locks)	82
• накладные (rim lock)	86

Фурнит ура для китайских металлических дверей (ручки и замки)	87
Accessories for PRC steel doors (Handles & locks)	
Фурнит ура для финских дверей (ручки, замки, накладки, петли)	88
Accessories for Finnish doors (Handles, Locks, hinges)	
Фурнит ура для раздвижных дверей (ролики, замки, направляющие)	89
Accessories for sliding doors	
Замки почтовые и мебельные. Furniture lock and zip lock	91
Цилиндровые механизмы. Lock cylinders	
• цилиндры латунные (brass cylinder) MCM	92
• цилиндры (cylinder) DAMX	95
Навесные замки. Padlock	
• серия (series) TS (стальные) (steel)	97
• серия (series) TB (латунные) (brass)	98
• серия (series) VS (с защитой дужки) (With shackle protection)	99
• серия (series) WS, WB (П-образные) (U shaped locks)	100
• серия (series) TP, TE	101
• серия (series) TA	102
• кодовые и багажные (code & Luggage Padlock)	104
Дверные петли. Hinges	
• стальные универсальные (steel, Universal)	107
• стальные левые/правые (steel, Left/Right)	109
• латунные (brass)	111
• ввертные петли (Screw-in hinges)	112
Доводчики. Door closers	
• Серия (Series) D (рычажные) (with normal arm)	112
• Серия (Series) DD (со скользящей тягой) (with sliding arm)	114
• Серия (Series) DV (врезные) (mortise)	114
• Серия (Series) DT (пружинные) (spring)	114
Фурнит ура. Door accessories	
• Дверные молоточки. Door knockers	115
• Глазки дверные. Door viewers	116
• Стопора. Door stoppers	116
• Ригели. Door bolts	119
Разное. Different	120
Новинки. New products	121
Рекламные материалы. Advertising materials	124

AB: Бронза	GP: Золото
AC: Медь	GR: Графит
AM: Антик медь	MAB: Бронза матовая
AS: Антик серебро	MBR: Коричневый матовый
AW: Дуб	PB: Полированная латунь
BK: Черный	RW: Красное дерево
BN: Черный никель	SB: Матовая латунь
BR: Коричневый	SC: Матовый хром
BSN: Темный матовый никель	SG: Матовое золото
BW: Светлое дерево	SL: Серебро
CP (PN): Хром	SN: Мат никель
DW: Темное дерево	WH: Белый

Color options:

AB: Antique bronze	GP: Gold plate
AC: Antique Copper	GR: Graphite
AM: Copper color	MAB: Satin bronze
AS: Antique Silver	MBR: Matte Brown
AW: Oak Wood	PB: Polished brass
BK: Black	RW: Red wood
BN: Black Nickle	SB: Brushed brass
BR: Brown	SC: Satin chrome
BSN: Dark satin nickle	SG: Satin Gold
BW: Bright wood	SL: Silver
CP (PN): Chrome plated	SN: Satin nickel
DW: Dark Wood	WH: White

Материал ручек и розетки ЦАМ. Подпружиненные. Износостойкое многослойное покрытие. Крепление саморезами или стяжками.

d = 52 мм

Material of handles and escutcheons is zink. Resistant multi-layer plating. Can fixing with normal self-tapping screws or with security tie screws.

C802

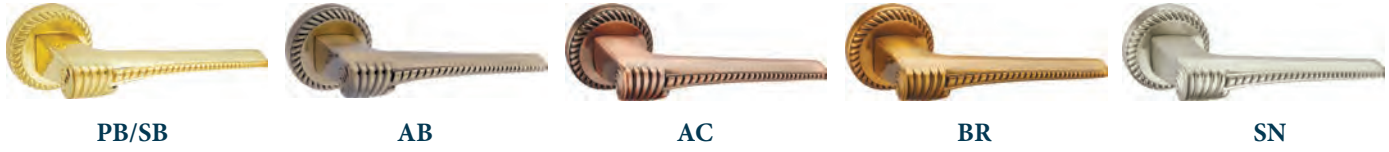

C803



C804



C889



CW1

Накладка-фиксатор
Locking plate



C1

Накладка на цилиндр
Cylinder cover plate



Ручки дверные «D»

Round plate handles «D»



Материал ручек и розетки ЦАМ. Подпружиненные.
Износостойкое многослойное покрытие.
Крепление саморезами или стяжками.

d = 54 мм

Material of handles and escutcheons is zink. Resistant
multi-layer plating. Can fixing with normal self-tapping
screws or with security tie screws.

D250



D251



D252



D253



E370



E371



Материал ручек и розетки ЦАМ. Подпружиненные. Износостойкое многослойное покрытие. Крепление саморезами или стяжками.

d = 54 мм

Material of handles and escutcheons is zink. Resistant multi-layer plating. Can fixing with normal self-tapping screws or with security tie screws.

K790



K791



K792



K793



K794



K795



Материал ручек и розетки ЦАМ. Подпружиненные.
Износостойкое многослойное покрытие.
Крепление саморезами или стяжками.

Material of handles and escutcheons is zink. Resistant
multi-layer plating. Can fixing with normal self-tapping
screws or with security tie screws.

E433

d = 54 мм



PB/SB



AB



AC



BR



SN



BK/PB



BK/SN



WH/PB



WH/SN

E1



BK/PB



BK/SN

EW1

Новые цвета



BK/PB



BK/SN



WH/PB



WH/SN



MAB



WH/PB



WH/SN



MAB

D1



WH/PB



WH/SN



Кор. 144 / упак. 12 шт.
Ctn. 144 / box 12 pcs

DW1



WH/PB



WH/SN



Кор. 60 / упак. 10 шт.
Ctn. 60 / box 10 pcs

Дверные накладки «К, Е, D»

Door escutcheons «K, E, D»



Материал ручек и розетки ЦАМ. Подпружиненные.
Износостойкое многослойное покрытие.
Крепление саморезами или стяжками.

Material of handles and escutcheons is zink. Resistant
multi-layer plating. Can fixing with normal self-tapping
screws or with security tie screws.

d = 53 мм

K1



PB/CP



PB/SB



AB



AC



BR



MAB



BK/PB



BK/SN



WH/PB



WH/SN



SN



Кор. 144 / упак. 12 шт.
Ctn. 144 / box 12 pcs

E1



PB



AB



AC



BR



SN

D1



PB/CP



PB/SB



AB



AC



BR



SN

KW1



PB



PB/SB



AB



AC



BR



MAB



BK/PB



BK/SN



WH/PB



WH/SN



SN



Кор. 60 / упак. 10 шт.
Ctn. 60 / box 10 pcs

EW1



PB



AB



AC



BR



SN

DW1



PB



PB/SB



AB



AC



BR



SN

Материал ручек и розетки ЦАМ. Подпружиненные.
Износостойкое многослойное покрытие.
Крепление саморезами или стяжками.

d = 53 мм

Material of handles and escutcheons is zink. Resistant
multi-layer plating. Can fixing with normal self-tapping
screws or with security tie screws.

N412



PB/SB



AB/CP



AC/CP



BR/CP



GR/CP



BN/PB



BN/CP



SN/CP

N424



PB/SB



AB/BK



GR



CP



WH/PB



WH/SN



BR/BK



BK/PB



BK/SN



SN/CP

N641



PB/SB



AB/BK



SN/CP

N643



PB



AB/BK



AC/BK



BK/PB



BK/SN



BR/BK



SN/CP



Коп. 12 шт.
ctn. 12 pcs.

Ручки дверные «N»

Материал ручек и розетки ЦАМ. Подпружиненные.
Износостойкое многослойное покрытие.
Крепление саморезами или стяжками.

d = 53 мм

Material of handles and escutcheons is zink. Resistant
multi-layer plating. Can fixing with normal self-tapping
screws or with security tie screws.

N645



N646

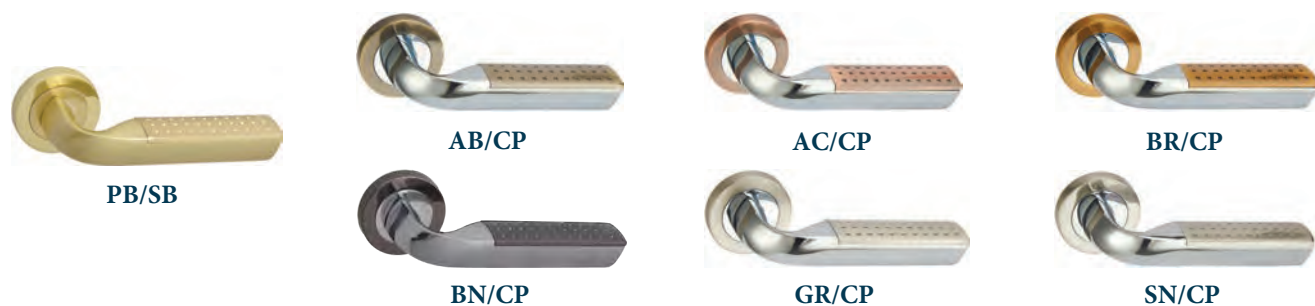

N648

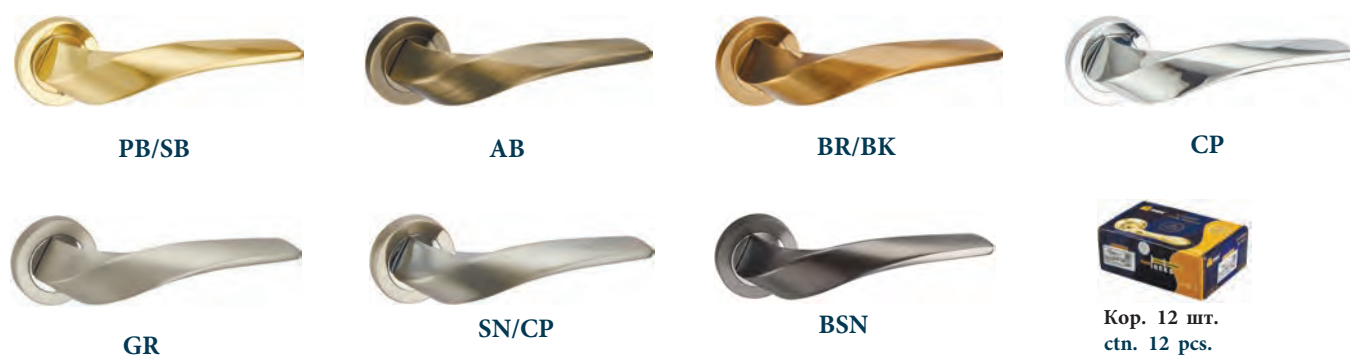

N649



Материал ручек и розетки ЦАМ. Подпружиненные. Износостойкое многослойное покрытие. Крепление саморезами или стяжками.

d = 53 мм

Material of handles and escutcheons is zink. Resistant multi-layer plating. Can fixing with normal self-tapping screws or with security tie screws.

N650



N651

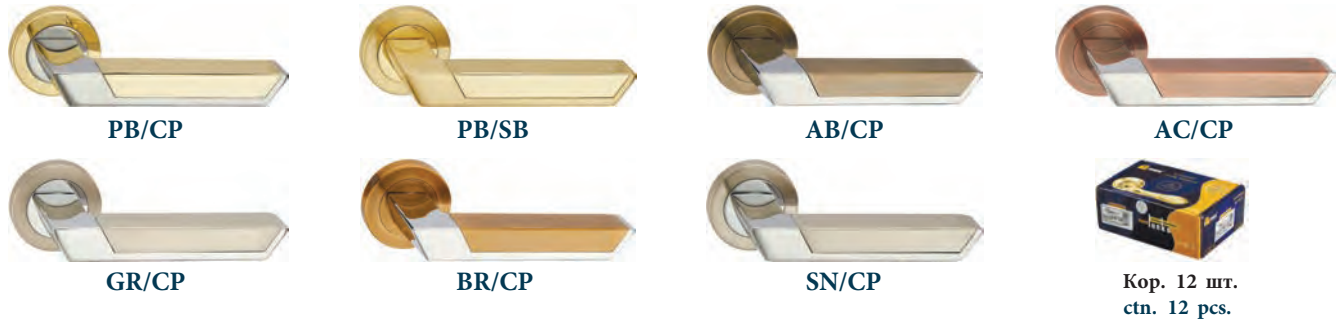

N652

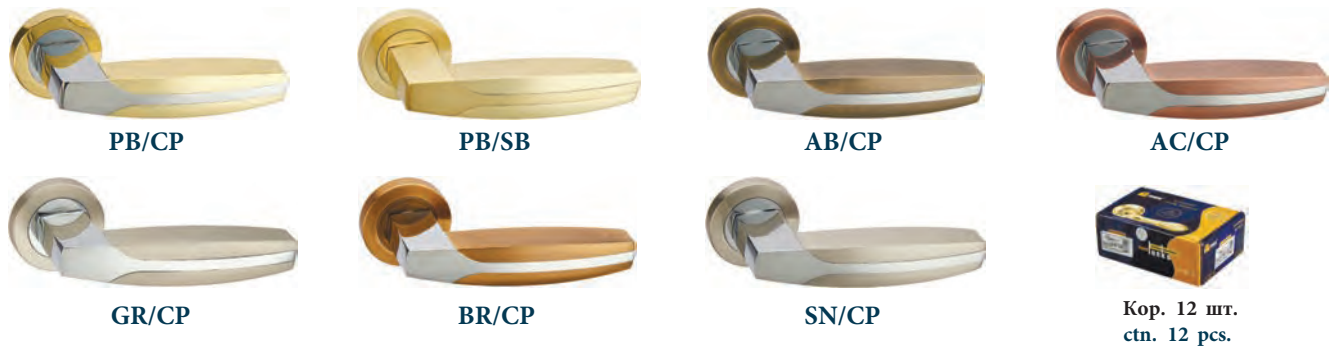

N801



Ручки дверные «N»

Round plate handles «N»



Материал ручек и розетки ЦАМ. Подпружиненные.
Износостойкое многослойное покрытие.
Крепление саморезами или стяжками.

d = 53 мм

Material of handles and escutcheons is zink. Resistant
multi-layer plating. Can fixing with normal self-tapping
screws or with security tie screws.

N888



SB



AC



CP



Коп. 12 шт.
ctn. 12 pcs.

N901



PB



SB



AB



BR



BK/PB



BK/SN



CP



SN

N902



PB/CP



PB/SB



AB/CP



AC/CP



BR/CP



GR/CP



SN/CP



Коп. 12 шт.
ctn. 12 pcs.

N903



PB/CP



PB/SB



AB/CP



AC/CP



BR/CP



GR/CP



SN/CP



Коп. 12 шт.
ctn. 12 pcs.

Материал ручек и розетки ЦАМ. Подпружиненные. Износостойкое многослойное покрытие. Крепление саморезами или стяжками.

Material of handles and escutcheons is zink. Resistant multi-layer plating. Can fixing with normal self-tapping screws or with security tie screws.

d = 53 мм

N904



PB



SB/PB



AB/BK



AC/BK



WH/PB



WH/SN



BK/PB



BK/SN



BR/BK



GR



SN/CP



CP

N905



PB



SB/PB



AB/BK



AC/BK



WH/PB



WH/SN



BK/PB



BK/SN



BR/BK



GR



SN/CP



CP

NB612

d = 55 мм



PB/SB



AB/CP



AC/CP



BR/CP



BN/PB



BN/CP



GR/CP



SN/CP

Накладки и завертки к ручкам «N»

Door escutcheons «N»



NW1

Материал ЦАМ. Износостойкое многослойное покрытие.

d = 53 мм

Material of escutcheons is zink. Resistant multi-layer plating.



PB

PB/SB

SB/PB

AB

AC

BR

GR/CP

WH/PB

WH/SN

BK/PB

BK/SN

BN/PB

BN/CP

CP

SN/CP

BSN

- НОВИНКА

N1

d = 53 мм



PB

PB/SB

SB/PB

AB

AC

BR

GR/CP

WH/PB

WH/SN

BN/PB

BN/CP

BK/PB

BK/SN

CP

SN/CP

BSN

- НОВИНКА

NB1

d = 55 мм



PB/SB

AB

AC

BR

BN/CP

BN/PB

GR/CP

SN/CP



Кор. 144 / упак. 12 шт.
Стн. 144 / box 12 pcs

NBW1

d = 55 мм



PB/SB

AB

AC

BR

BN/CP

BN/PB

GR/CP

SN/CP



Кор. 60 / упак. 10 шт.
Стн. 60 / box 10 pcs

Материал ручек и розетки ЦАМ. Подпружиненные. Износостойкое многослойное покрытие. Крепление саморезами или стяжками.

Material of handles and escutcheons is zink. Resistant multi-layer plating. Can fixing with normal self-tapping screws or with security tie screws.

d = 54 мм

R160



R400

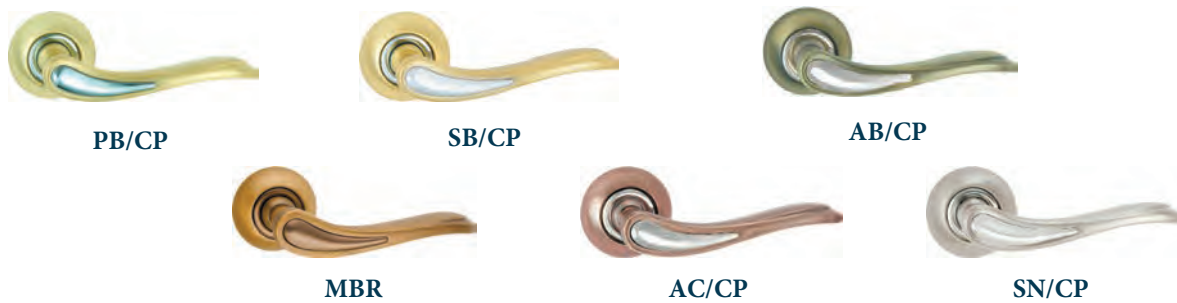

R401



R402

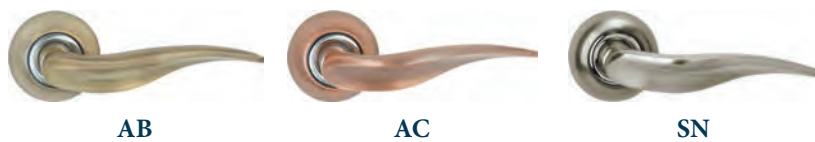

Коп. 12 шт.
ctn. 12 pcs.

R403



R404

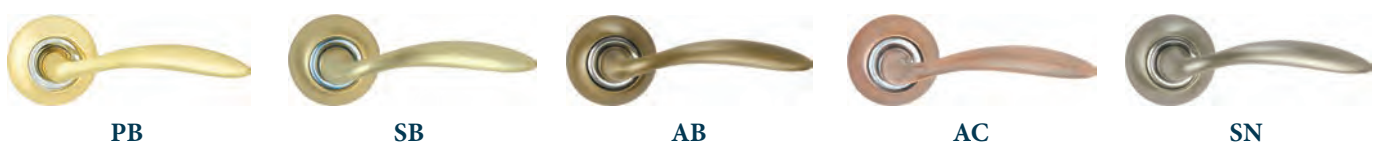

Ручки дверные «R»

Материал ручек и розетки ЦАМ. Подпружиненные.
Износостойкое многослойное покрытие.
Крепление саморезами или стяжками.

d = 54 мм

Material of handles and escutcheons is zink. Resistant
multi-layer plating. Can fixing with normal self-tapping
screws or with security tie screws.

R405



PB



SB



AB



AC



SN



MBR



CP



Кор. 12 шт.
ctn. 12 pcs.

R406



PB/CP



SB/CP



AB/CP



AC/CP



SN/CP



SB/PB

R407



PB



SB



AB



AC



BK/PB



BK/SN



WH/PB



WH/SN



CP



SN/CP



BR

R408



AB



AC



SN

R409



PB/CP



AC



AC/CP

R410



PB/CP



SB/PB



AB/CP



PB/SB



SB/CP



AC/CP



SN/CP

Материал ручек и розетки ЦАМ. Подпружиненные. Износостойкое многослойное покрытие. Крепление саморезами или стяжками.

Material of handles and escutcheons is zink. Resistant multi-layer plating. Can fixing with normal self-tapping screws or with security tie screws.

d = 54 мм

R411



SB



AB



AC



SN

R412



PB/SB



SB/PB



AB



AC



MBR



SN/CP



PB/DW



SB/BW



SN/AW



SN/RW

R413



PB/SB



SB/PB



AB



AC



SN/CP

R414



PB



SB



AB



AC



SN

R415



PB



SB



AB



AC



SN/CP

R416



SN/CP



PB/CP



AC/CP

Ручки дверные «R»

Round plate handles «R»



Материал ручек и розетки ЦАМ. Подпружиненные.
Износостойкое многослойное покрытие.
Крепление саморезами или стяжками.

d = 54 мм

Material of handles and escutcheons is zink. Resistant
multi-layer plating. Can fixing with normal self-tapping
screws or with security tie screws.

R417



PB/SB



SN/CP



PB/DW



SB/BW



AC



SN/AW



SN/RW



Коп. 12 шт.
ctn. 12 pcs.

R418



SB/PB



AB/CP

R418-1

Новинка !



SB



SN/CP



PB/SB



AB/PB



AB



SN

R419



PB/SB



AB



AC



SN/CP



SB/PB

R420



PB/CP



PB/SB



SB/PB



PB/SB

AB/CP



AC/CP



PB/DW



SB/BW



SN/AW



SN/RW



SN/CP

R421



PB/SB



SB/CP



SN/CP



SB/PB



AC/CP



Коп. 12 шт.
ctn. 12 pcs.

Материал ручек и розетки ЦАМ. Подпружиненные. Износостойкое многослойное покрытие. Крепление саморезами или стяжками.

Material of handles and escutcheons is zink. Resistant multi-layer plating. Can fixing with normal self-tapping screws or with security tie screws.

d = 54 мм

R422



PB



AB



AC



BR



SB/PB



SN/CP



Коп. 12 шт.
ctn. 12 pcs.

R423



PB/SB



PB1/SB1



SB1/PB1



AB



SN/CP

R424



PB



SB/PB



AB



SN/CP



PB 1



AC



Коп. 12 шт.
ctn. 12 pcs.

R426



AB



PB



SB



AC



BR

R428



PB/CP



PB/SB



AB/CP



BR/CP



AC/CP



GR/CP



SN/CP



Коп. 12 шт.
ctn. 12 pcs.

Ручки дверные «R»

Round plate handles «R»



Материал ручек и розетки ЦАМ. Подпружиненные.
Износостойкое многослойное покрытие.
Крепление саморезами или стяжками.

d = 54 мм

Material of handles and escutcheons is zink. Resistant
multi-layer plating. Can fixing with normal self-tapping
screws or with security tie screws.

R430



PB/CP



SB/PB



PB/DW



SB/BW



AB/CP



AC/CP



SN/RW



SN/AW



BR/CP



SN/CP



Коп. 12 шт.
ctn. 12 pcs.

R432



PB 1



AB



BR



SN



SB1



AC



MBR - мало на остатке

R433



PB



SB



AB



WH/PB



PB 1/SB 1



PB 1

мало на остатке



BR



AC



WH/SN



BK/PB



SN



BK/SN

R434



PB/CP



SB/PB



AB/CP



BR/CP



AC/CP



CP/SN



SN/CP



Коп. 12 шт.
ctn. 12 pcs.

Материал ручек и розетки ЦАМ. Подпружиненные. Износостойкое многослойное покрытие. Крепление саморезами или стяжками.

Material of handles and escutcheons is zink. Resistant multi-layer plating. Can fixing with normal self-tapping screws or with security tie screws.

d = 54 мм

R436



PB



SB



AB



AC



CP



BR



SN

R437



PB/SB



AB



AC



BR



SN



WH/PB



WH/SN



BK/PB



BK/SN

R438



PB/SB



SB/PB



AB



AC



BR



SN



CP



Коп. 12 шт.
ctn. 12 pcs.

R439



PB



SB



AB



BR



AC



CP



SN



Коп. 12 шт.
ctn. 12 pcs.

Ручки дверные «R»

Материал ручек и розетки ЦАМ. Подпружиненные.
Износостойкое многослойное покрытие.
Крепление саморезами или стяжками.

d = 54 мм

Material of handles and escutcheons is zinc. Resistant
multi-layer plating. Can fixing with normal self-tapping
screws or with security tie screws.

R440



R504

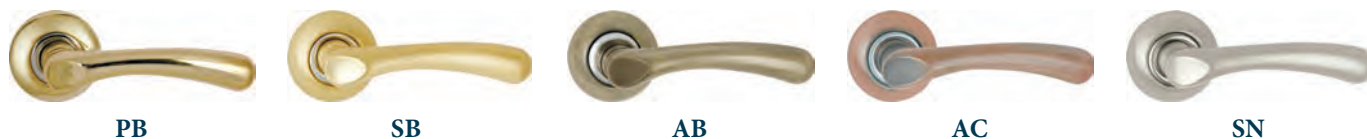

R610



R642



R649



Материал ручек и розетки ЦАМ. Подпружиненные. Износостойкое многослойное покрытие. Крепление саморезами или стяжками.

Material of handles and escutcheons is zink. Resistant multi-layer plating. Can fixing with normal self-tapping screws or with security tie screws.

d = 54 мм

R429



R431

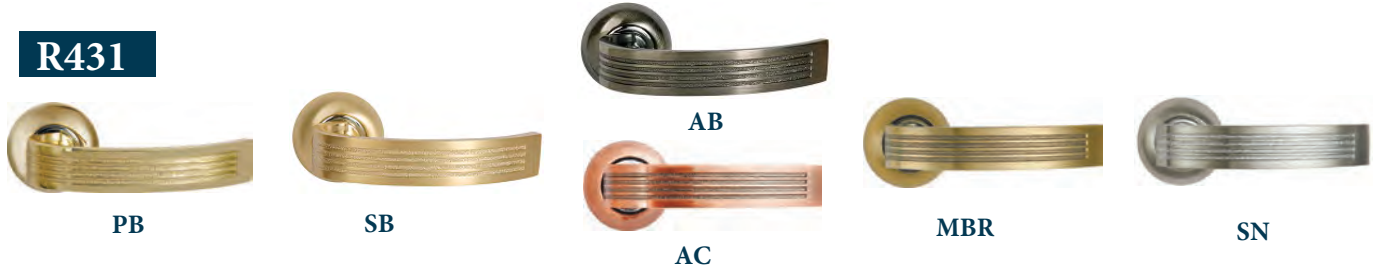

R500



R500-A



NEW! NC501 - в Новинках, см. Лист 122

R425



AC- последние на остатке

R427



R435



Кор. 12 шт.
ctn. 12 pcs.

Накладки дверные

Материал накладок ЦАМ. Подпружиненные. Износостойкое многослойное покрытие. Крепление саморезами или стяжками.

d = 54 мм

Material of escutcheons is zink. Resistant multi-layer plating. Can fixing with normal self-tapping screws or with security tie screws.

RW1



Кор. 60 / упак. 10 шт.
Ctn. 60 / box 10 pcs

- новинка

R1



Кор. 144 / упак. 12 шт.
Ctn. 144 / box 12 pcs

- новинка

R11



Q2



Материал ручек - алюминий, розеток - ЦАМ.
Подпружиненные. Износостойкое многослойное покрытие. Крепление саморезами или стяжками.

d = 54 мм

Material of handles is aluminum, Material of escutcheons is zink. Resistant multi-layer plating. Can fixing with normal self-tapping screws or with security tie screws.

W117



PB



SB



AB/BK



AC/BK



BR/BK



CP



SN/CP



Кор. 18 шт.
ctn. 18 pcs.

W118



AB/BK



AC/BK



SB нет, ожидаем в 2024-



BR/BK



SN/CP нет, ожидаем в 2024 -



Кор. 18 шт.
ctn. 18 pcs.

W161



PB



SB



AB/BK



AC/BK



BR/BK



CP



SN/CP



Кор. 18 шт.
ctn. 18 pcs.

W164



PB



SB



AB



AC



BR



CP



SN



Кор. 18 шт.
ctn. 18 pcs.

Ручки дверные DAMX «W»

DAMX Round plate handles «W»



Материал ручек - алюминий, розеток - ЦАМ.
Подпружиненные. Износостойкое многослойное покрытие. Крепление саморезами или стяжками.

d = 54 мм

Material of handles is aluminum, Material of escutcheons is zink. Resistant multi-layer plating. Can fixing with normal self-tapping screws or with security tie screws.

W407



W650



W1



WW1



-нет, ожидаем в 2024-

R104

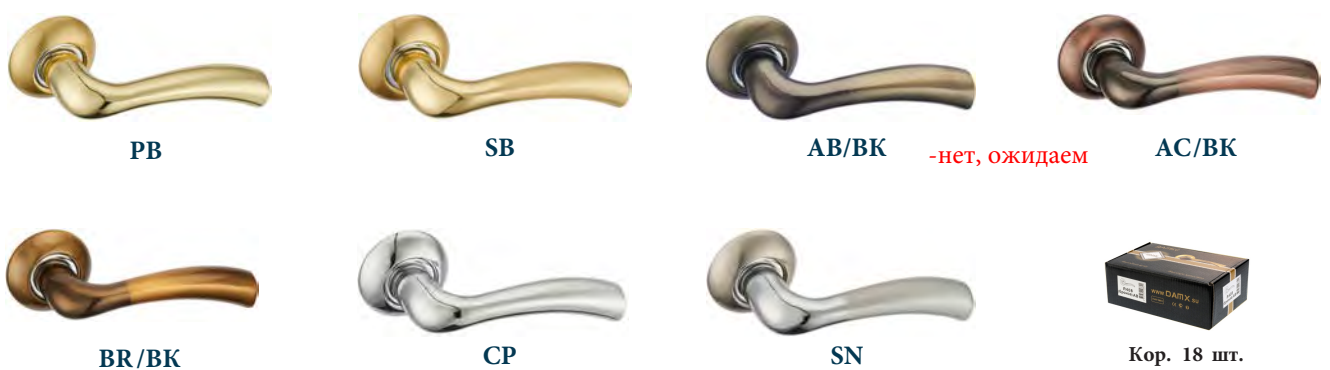

Кор. 18 шт.
ctn. 18 pcs.

Материал ручек - алюминий, розеток - ЦАМ.
Подпружиненные. Износостойкое многослойное покрытие. Крепление саморезами или стяжками.

d = 54 мм

Material of handles is aluminum, Material of escutcheons is zink. Resistant multi-layer plating. Can fixing with normal self-tapping screws or with security tie screws.

R105



PB



SB/PB



AB/BK



AC/BK



BR/BK



CP



SN/CP



Кор. 18 шт.
ctn. 18 pcs.

R106



PB



SB/PB



AB/BK -нет, ожидаем в 2024



AC/BK



BR/BK



CP



SN/CP



Кор. 18 шт.
ctn. 18 pcs.

R107



PB



SB/PB



AB/BK



AC/BK



BR/BK



CP



SN/CP



Кор. 18 шт.
ctn. 18 pcs.

R108



PB



SB



AB



AC



BR



CP



SN



Кор. 18 шт.
ctn. 18 pcs.

Ручки дверные DAMX «R»

DAMX Round plate handles «R»



Материал ручек - алюминий, розеток - ЦАМ.
Подпружиненные. Износостойкое многослойное покрытие. Крепление саморезами или стяжками.

d = 54мм

Material of handles is aluminum, Material of escutcheons is zink. Resistant multi-layer plating. Can fixing with normal self-tapping screws or with security tie screws.

R117



PB



SB/PB



AB/BK



AC/BK



BR/BK



CP



SN/CP



Кор. 18 шт.
ctn. 18 pcs.

R118



AB/BK



AC/BK



BR/BK



SB

-нет, ожидаем в 2024



SN/CP



Кор. 18 шт.
ctn. 18 pcs.

R161



PB



SB



AB/BK



AC/BK



BR/BK



CP



SN/CP



Кор. 18 шт.
ctn. 18 pcs.

R163



PB



AB/BK



AC/BK



BR/BK



CP



SN/CP



Кор. 18 шт.
ctn. 18 pcs.

Материал ручек - алюминий, розеток - ЦАМ.
Подпружиненные. Износостойкое многослойное покрытие. Крепление саморезами или стяжками.

d = 54 мм

Material of handles is aluminum, Material of escutcheons is zink. Resistant multi-layer plating. Can fixing with normal self-tapping screws or with security tie screws.

R164



PB



SB/PB



AB



AC



BR



CP



SN



Коп. 18 шт.
ctn. 18 pcs.

R400



PB/CP



SB/PB



AB/CP



AC/CP



BR/CP



BK/WH



BN/CP



GR/CP



SN/CP



Коп. 18 шт.
ctn. 18 pcs.

R405



PB



SB



AB



AC



SN

R407



PB



SB



AB



AC



SN



BR



CP



Коп. 18 шт.
ctn. 18 pcs.

Ручки дверные DAMX «R»

DAMX Round plate handles «R»



Материал ручек - алюминий, розеток - ЦАМ.
Подпружиненные. Износостойкое многослойное покрытие. Крепление саморезами или стяжками.

d = 54mm

Material of handles is aluminum, Material of escutcheons is zinc. Resistant multi-layer plating. Can fixing with normal self-tapping screws or with security tie screws.

R408



Кор. 18 шт.
ctn. 18 pcs.

R410

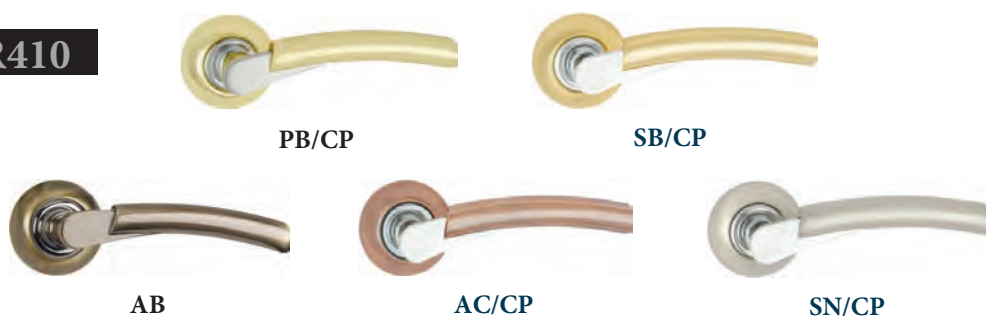

Кор. 18 шт.
ctn. 18 pcs.

R412

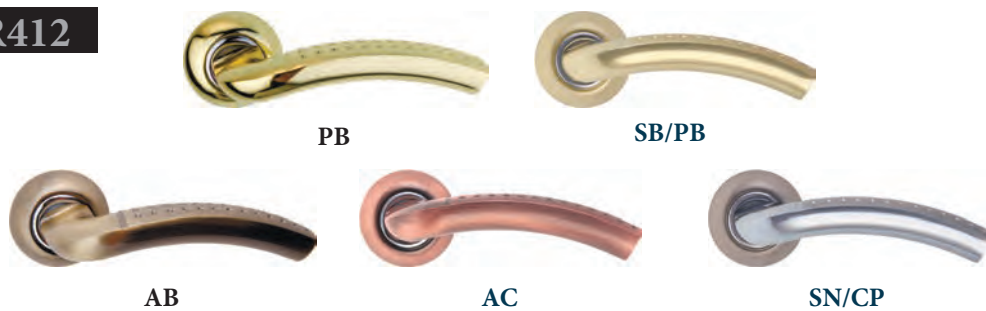

Кор. 18 шт.
ctn. 18 pcs.

R650

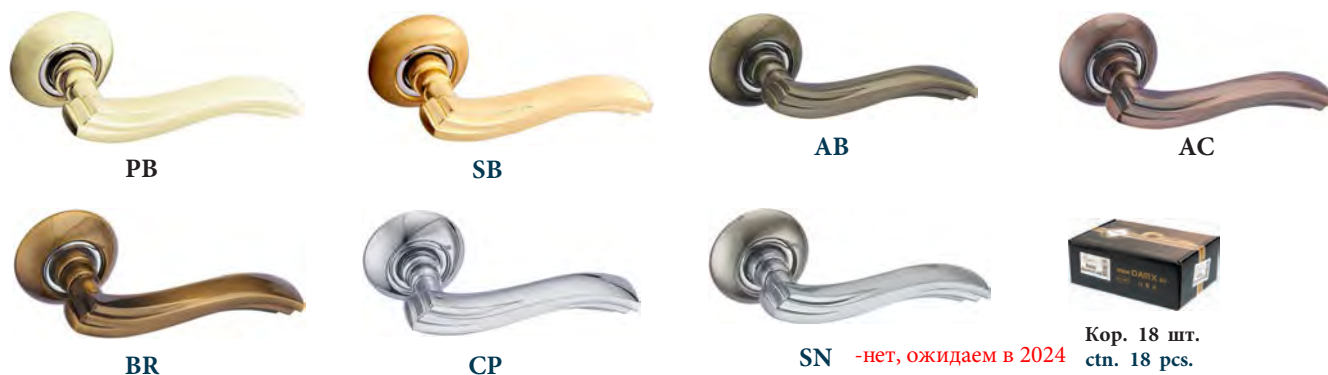

Кор. 18 шт.
ctn. 18 pcs.

SN -нет, ожидаем в 2024

Материал ручек и розетки ЦАМ. Подпружиненные. Износостойкое многослойное покрытие. Крепление саморезами или стяжками.

Material of handles and escutcheons is zink. Resistant multi-layer plating. Can fixing with normal self-tapping screws or with security tie screws.

U901



AB



AC



BR



BK/PB



CP



SN



MAB



BK/SN

U902



AB/CP



AC/CP



BR/CP



GR/CP



SN/CP



BSN/CP



MAB



BSN/GP



Коп. 12 шт.
ctn. 12 pcs.

U903



AB/CP



AC/CP



BR/CP



GR/CP



SN/CP



CP/BN



BN/CP



BN/WH



BSN/CP



CP/WH



WH/CP



WH/BN



BSN/GR



MAB/GR

Ручки дверные «U»

Материал ручек и розетки ЦАМ. Подпружиненные.
Износостойкое многослойное покрытие.
Крепление саморезами или стяжками.

Material of handles and escutcheons is zink. Re-
sistant multi-layer plating. Can fixing with normal
self-tapping screws or with security tie screws.

U904



U905



Новые ручки U422 BSN, MAB и SN/CP - см Л. 122 "Новинки"

UW1



Материал ручек и розетки ЦАМ. Подпружиненные.
Износостойкое многослойное покрытие.
Крепление саморезами или стяжками.

Material of handles and escutcheons is zink. Resistant
multi-layer plating. Can fixing with normal self-tapping
screws or with security tie screws.

U1

								
AB/CP	AB	AC/CP	AC	BR	BR/CP	GR/CP		
								
BK/SN	BK/PB	CP	SN/CP	MAB	BSN/CP	Кор. 144 / упак. 12 шт. Ctn. 144 / box 12 pcs		
								
BN/CP	BN/WH	CP/BN	CP/WH	WH/BN	WH/CP	WH/PB	WH/SN	MAB/GR

AW1

						
AB/CP	AB	AC/CP	AC	BR/CP	BR	
						
BK/PB	BK/SN	BN/PB	BN/CP	CP	GR/CP	SN/CP
						
WH/PB	WH/SN	BSN/CP	MAB - новинка	Кор. 60 / упак. 10 шт. Ctn. 60 / box 10 pcs		

A1

						
AB/CP	AB	AC/CP	AC	BK/PB	BK/SN	
						
BN/CP	BN/PB	BR/CP	BR	GR/CP	CP	SN/CP
						
WH/PB	WH/SN	BSN/CP	MAB - новинка	Кор. 144 / упак. 12 шт. Ctn. 144 / box 12 pcs		

Материал ручек и розетки ЦАМ. Подпружиненные. Износостойкое многослойное покрытие. Крепление саморезами или стяжками.

Material of handles and escutcheons is zink. Resistant multi-layer plating. Can fixing with normal self-tapping screws or with security tie screws.

A612



SN/CP



AB/CP



AC/CP



BR/CP



BN/CP



BN/PB



GR/CP



Коп. 12 шт.
ctn. 12 pcs.

A645



AB



MAB - новинка



AC



BR



BK/PB



BK/SN



WH/PB



WH/SN



GR



BSN



CP



SN/CP

A646



GR/CP



AB/CP



AC/CP



BR/CP



BN/CP



BN/PB



SN/CP



Коп. 12 шт.
ctn. 12 pcs.

A647



AB/CP



AC/CP



GR/CP



BN/CP



BN/PB



SN/CP



Коп. 12 шт.
ctn. 12 pcs.

Ручки дверные «А»

Square plate handles «A»



Материал ручек и розетки ЦАМ. Подпружиненные.
Износостойкое многослойное покрытие.
Крепление саморезами или стяжками.

Material of handles and escutcheons is zink. Resistant
multi-layer plating. Can fixing with normal self-tapping
screws or with security tie screws.

A648

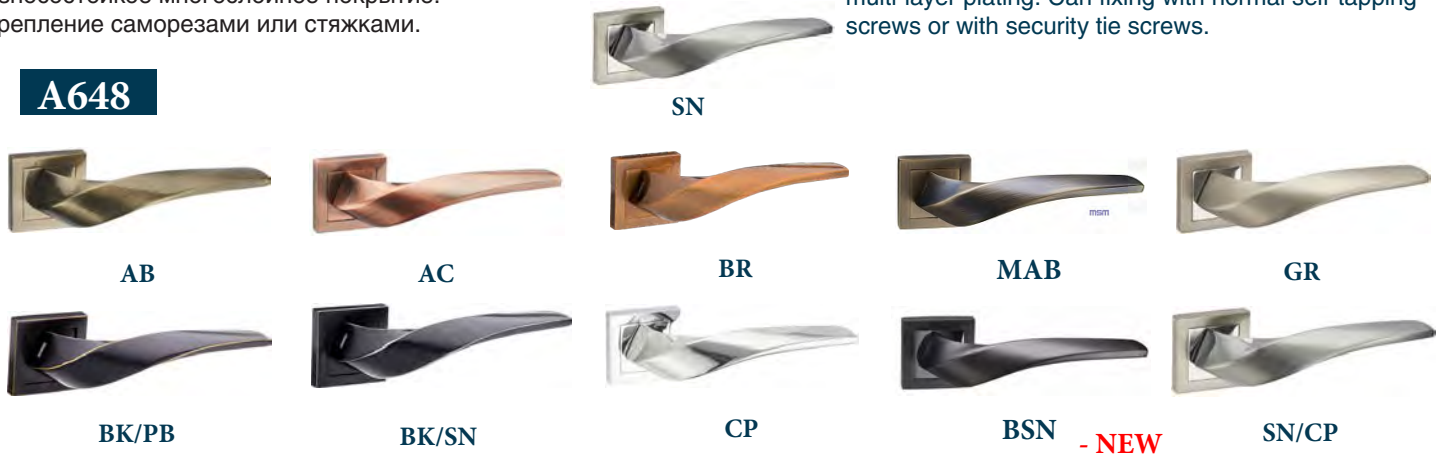

A649



A650



A651

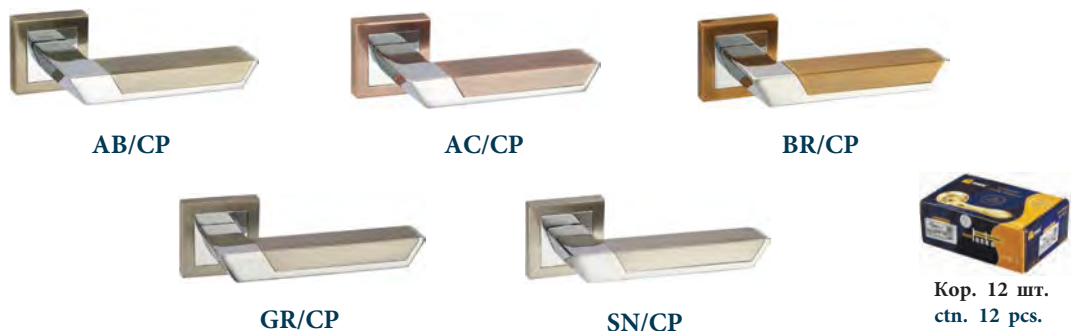

Материал ручек и розетки ЦАМ. Подпружиненные. Износостойкое многослойное покрытие. Крепление саморезами или стяжками.

Material of handles and escutcheons is zink. Resistant multi-layer plating. Can fixing with normal self-tapping screws or with security tie screws.

A652



A653

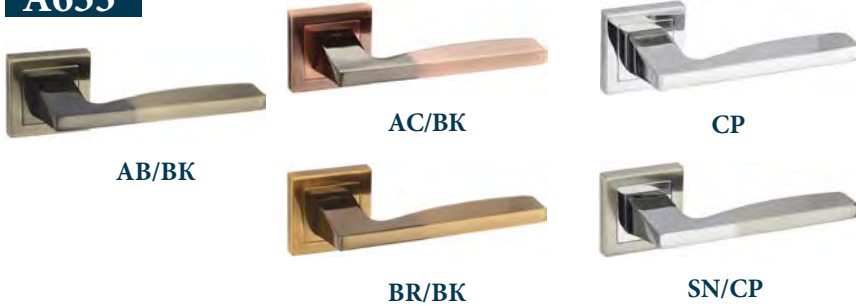

A643



A640 - новые ручки -
см. в конце каталога "Новинки"

Накладки «SW1, S1, S11»

Cylinder Plate «SW1, S1, S11»

SW1



S1



Кор. 144 / упак. 12 шт.
Ctn. 144 / box 12 pcs

S11



Кор. 144 / упак. 12 шт.
Ctn. 144 / box 12 pcs

Ручки дверные «S»

Материал ручек и розетки ЦАМ. Подпружиненные.
Износостойкое многослойное покрытие.
Крепление саморезами или стяжками.

Material of handles and escutcheons is zink. Resistant
multi-layer plating. Can fixing with normal self-tapping
screws or with security tie screws.

S613

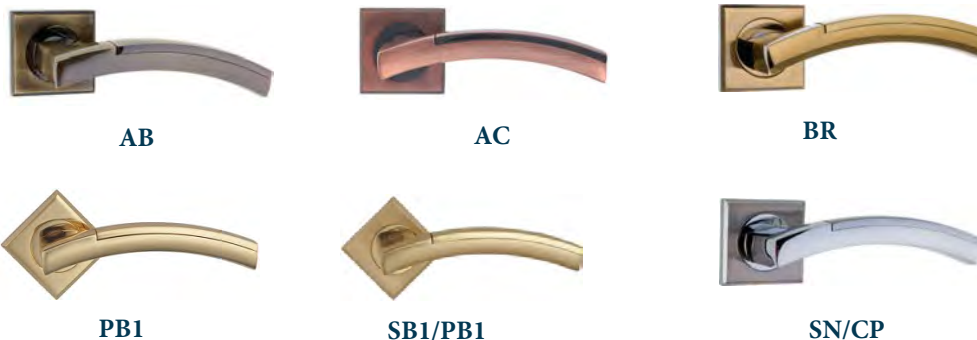

S640



Аналог A640: AB, GR, SN/CP
см. в конце каталога - "Новинки"

S641

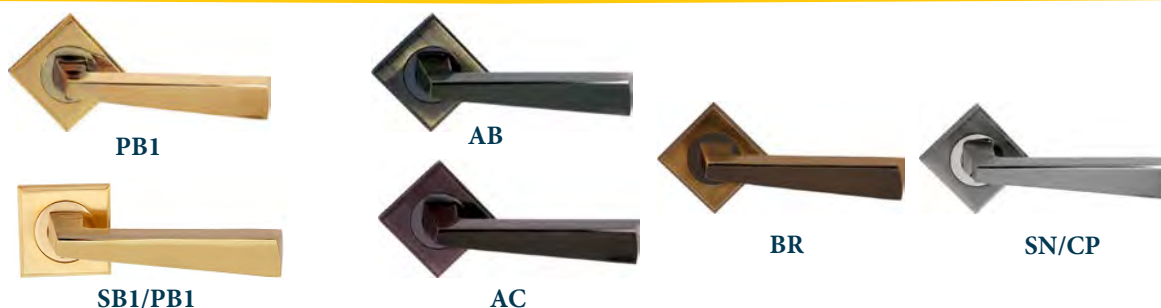

S642

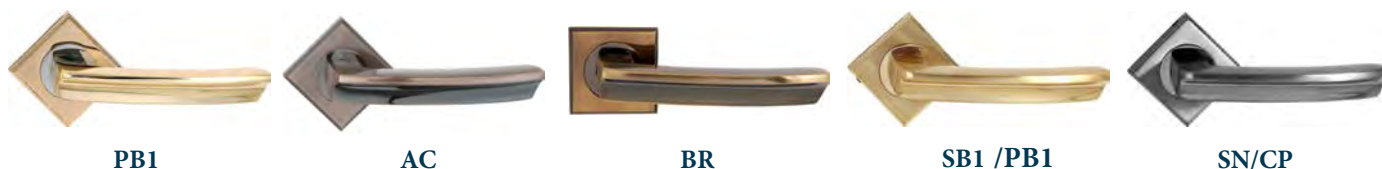

S643

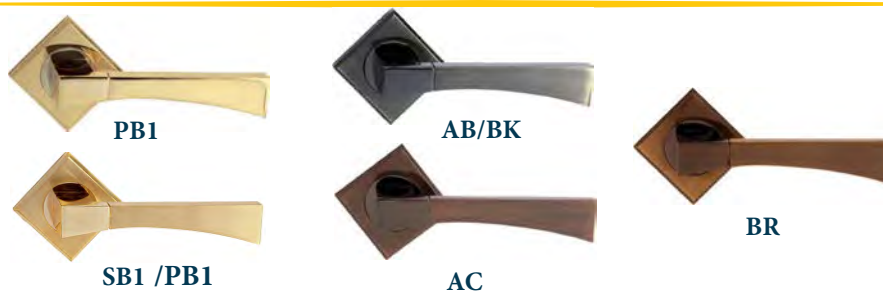

S644



Литые ручки и планки. ЦАМ.
Износостойкое многослойное покрытие.
Крепление саморезами или стяжками.

Material of handles is zink. Resistant multi-layer plating.
Can fixing with normal self-tapping screws or with security tie screws.

250L

Габаритный размер (Total plate length) - 280 мм



PB/SB



AB



AC



BR



SN/CP



Кор. 9 шт.
ctn. 9 pcs.

251L

Габаритный размер (Total plate length) - 280 мм



PB/SB



AB



AC



BR



SN



Кор. 9 шт.
ctn. 9 pcs.

253L

Габаритный размер (Total plate length) - 280 мм



PB/SB



AB



AC



BR



SN

Ручки на планке 85 мм

Plate door handles 85 mm



Литые ручки и планки. ЦАМ.
Износостойкое многослойное покрытие.
Крепление саморезами или стяжками.

Material of handles is zink. Resistant multi-layer plating.
Can fixing with normal self-tapping screws or with security tie screws.

370L

Габаритный размер (Total plate length) - 280 мм



PB/SB



AB



BR



AC



MAB



SN/CP

371L

Габаритный размер (Total plate length) - 295 мм



PB/SB



AB



AC



MAB



BR



SN

429L

Габаритный размер (Total plate length) - 316 мм



PB/SB



SB



AB



AC



MAB



BR



SN/CP

790L

Габаритный размер (Total plate length) - 265 мм



PB/SB



AB



AC



MAB



BR



SN

Литые ручки и планки. ЦАМ.
Износостойкое многослойное покрытие.
Крепление саморезами или стяжками.

Material of handles is zink. Resistant multi-layer plating.
Can fixing with normal self-tapping screws or with security tie screws.

791L

Габаритный размер (Total plate length) - 284 мм



PB



AB



AC



BR



SN

405L-G

Габаритный размер (Total plate length) - 267 мм

планка сталь



PB



SB/PB



AB



AC



BR



CP



SN/CP



Кор. 9 шт.
ctn. 9 pcs.

412L-A

Габаритный размер (Total plate length) - 264 мм



PB/CP



AB/CP



BR/CP



GR/CP

Ручки на планке 85 мм

Plate door handles 85 mm



Литые ручки и планки. ЦАМ.
Износостойкое многослойное покрытие.
Крепление саморезами или стяжками.

Material of handles is zink. Resistant multi-layer plating.
Can fixing with normal self-tapping screws or with security tie screws.

412L-A

продолжение
(continue)



BN/SN



BN/PB



SN/CP



Кор. 9 шт.
ctn. 9 pcs.

412L-B

Габаритный размер (Total plate length) - 249 мм



PB/SB



AB



BR



SN/CP

412L-C

Габаритный размер (Total plate length) - 243 мм



PB/SB



AB



BR



SN/CP

412L-G

Габаритный размер (Total plate length) - 267 мм

планка сталь



PB



SB/PB



AB



AC

Литые ручки и планки. ЦАМ.
Износостойкое многослойное покрытие.
Крепление саморезами или стяжками.

Material of handles is zink. Resistant multi-layer plating.
Can fixing with normal self-tapping screws or with security tie screws.

412L-G

продолжение
(continue)



CP



BR



SN/CP



Коп. 9 шт.
ctn. 9 pcs.

424L-A

Габаритный размер (Total plate length) - 264 мм



PB



SB



AB



MAB



BR



BK/PB



BK/SN



CP



BSN



SN

424L-D

Габаритный размер (Total plate length) - 258 мм



PB



AB



BR



BK/PB



BK/SN



CP



SN

Ручки на планке 85 мм

Plate door handles 85 mm



Литые ручки и планки. ЦАМ.
Износостойкое многослойное покрытие.
Крепление саморезами или стяжками.

Material of handles is zink. Resistant multi-layer plating.
Can fixing with normal self-tapping screws or with security tie screws.

612L-B

Габаритный размер (Total plate length) - 249 мм



PB/CP



AB/CP



BR/CP



BN/SN



BN/PB



SN/CP



Коп. 9 шт.
ctn. 9 pcs.

612L-C

Габаритный размер (Total plate length) - 243 мм



PB/SB



AB



BR



SN/CP

645L

Габаритный размер (Total plate length) - 258 мм



PB/SB



AB/BK



BR/BK



BK/PB

Литые ручки и планки. ЦАМ.
Износостойкое многослойное покрытие.
Крепление саморезами или стяжками.

Material of handles is zink. Resistant multi-layer plating.
Can fixing with normal self-tapping screws or with security tie screws.

645L

продолжение
(continue)



BK/SN



CP



MAB



SN



Кор. 9 шт.
ctn. 9 pcs.

646L

Габаритный размер (Total plate length) - 249 мм



PB/SB



AB



BR



BN/PB



BN/SN



SN/CP



Кор. 9 шт.
ctn. 9 pcs.

647L

Габаритный размер (Total plate length) - 264 мм



PB/CP



AB/CP



BR/CP



BN/PB



GR/CP



PB/SB



SN/CP



AC/CP



BN/SN



Кор. 9 шт.
ctn. 9 pcs.

Ручки на планке 85 мм

Литые ручки и планки. ЦАМ.
Износостойкое многослойное покрытие.
Крепление саморезами или стяжками.

Material of handles is zink. Resistant multi-layer plating.
Can fixing with normal self-tapping screws or with security tie screws.

649L

Габаритный размер (Total plate length) - 244 мм



PB/SB



AB/BK



BR/BK



BK/PB



BK/SN



CP



SN/CP

801L

Габаритный размер (Total plate length) - 250 мм



PB



AB



BR



BK/PB



BK/SN



SN/CP



Кор. 9 шт.
ctn. 9 pcs.

903L

Габаритный размер (Total plate length) - 264 мм



PB/CP



PB/SB



AB/CP



AC/CP

Литые ручки и планки. ЦАМ.
Износостойкое многослойное покрытие.
Крепление саморезами или стяжками.

Material of handles is zink. Resistant multi-layer plating.
Can fixing with normal self-tapping screws or with security tie screws.

903L

продолжение
(continue)



BR/CP



GR/CP



SN/CP



Кор. 9 шт.
ctn. 9 pcs.

904L

Габаритный размер (Total plate length) - 258 мм



PB



AB



CP



BK/SN



BK/PB



BR



SN/CP

905L

Габаритный размер (Total plate length) - 264 мм



PB



AB



BR



BK/BP



BK/SN



CP



SN

Ручки на планке 85 мм

Plate door handles 85 mm



Литые ручки и планки. ЦАМ.
Износостойкое многослойное покрытие.
Крепление саморезами или стяжками.

Material of handles is zink. Resistant multi-layer plating.
Can fixing with normal self-tapping screws or with security tie screws.

160L

Габаритный размер (Total plate length) - 240 мм



PB



SB



AB



AC



SN

405L

Габаритный размер (Total plate length) - 238 мм



PB



SB



AB



AC



BR



SN



Кор. 9 шт.
ctn. 9 pcs.

414L

Габаритный размер (Total plate length) - 238 мм



AB



Кор. 9 шт.
ctn. 9 pcs.

415L



PB



AB

Литые ручки и планки. ЦАМ.
Износостойкое многослойное покрытие.
Крепление саморезами или стяжками.

Material of handles is zink. Resistant multi-layer plating.
Can fixing with normal self-tapping screws or with security tie screws.

504L

Габаритный размер (Total plate length) - 238 мм



PB



SB



MBR



AB



AC



SN



Кор. 9 шт.
ctn. 9 pcs.

610L

Габаритный размер (Total plate length) - 238 мм



PB



AB



SN

405-85K

Межосевое (Center distance) - 85 мм.
L – левая(Left), R – правая (Right)



PB



SN

412-85K

Межосевое (Center distance) - 85 мм.
L – левая(Left), R – правая (Right)



CP



PB



SN

Литые ручки и планки. ЦАМ.
Износостойкое многослойное покрытие.
Крепление саморезами или стяжками.

Material of handles is zink. Resistant multi-layer plating.
Can fixing with normal self-tapping screws or with security tie screws.

405L-E

Межосевое (Center distance) - 85 мм

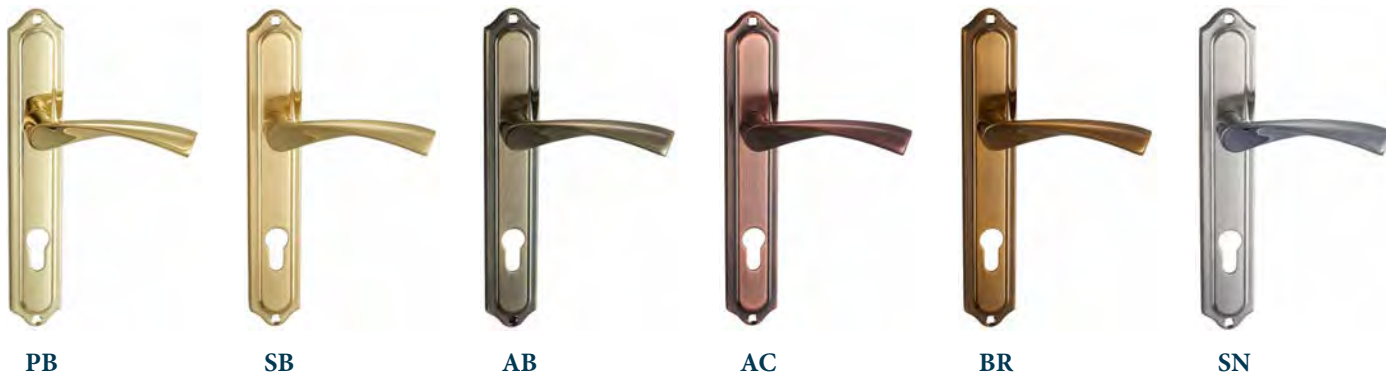

Коп. 9 шт.
ctn. 9 pcs.

412L

Межосевое (Center distance) - 85 мм

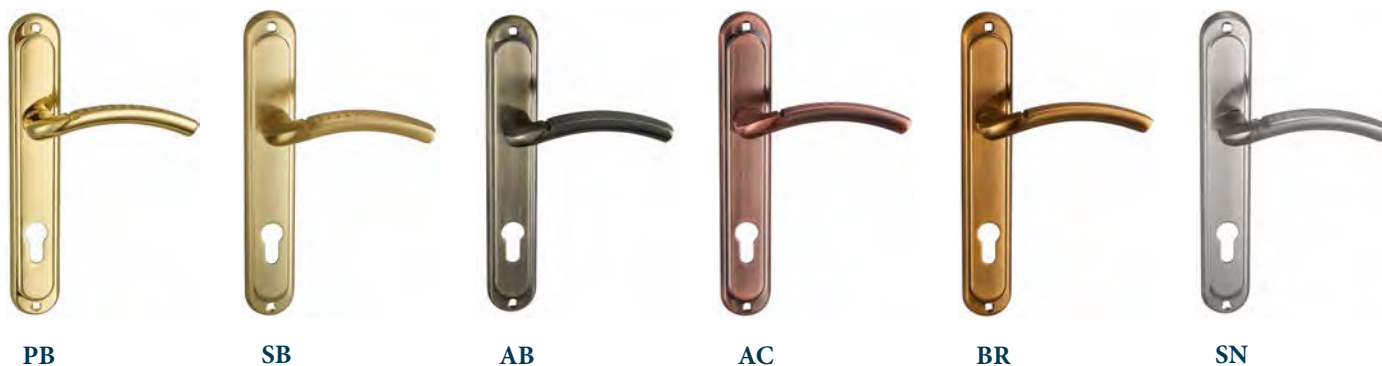

434L

Межосевое (Center distance) - 85 мм

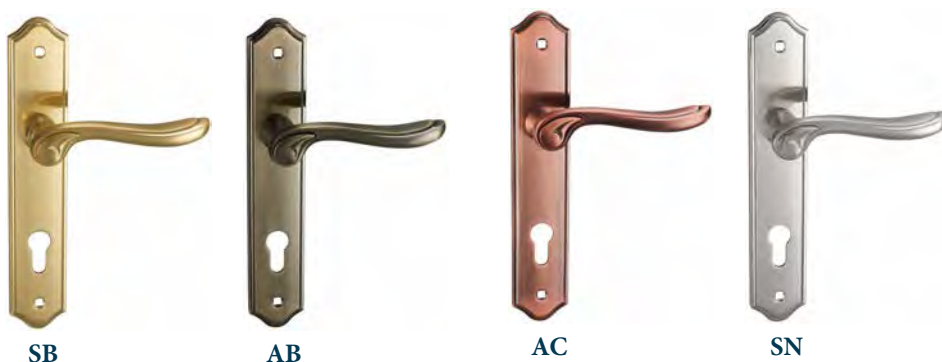

Коп. 9 шт.
ctn. 9 pcs.

Ручки на планке 55 мм

Plate door handles 55 mm



Литые ручки и планки. ЦАМ.
Износостойкое многослойное покрытие.
Крепление саморезами или стяжками.

Material of handles is zink. Resistant multi-layer plating.
Can fixing with normal self-tapping screws or with security tie screws.

160P



PB



AB



AC



BR



SN

412P



PB/SB



AB



SN/CP



Кор. 9 шт.
ctn. 9 pcs.

400V



PB/CP



AB/CP



SN/CP



Кор. 9 шт.
ctn. 9 pcs.

610V



PB



SB



AB



AC



BR



49

SN



Кор. 9 шт.
ctn. 9 pcs.

Литые ручки и планки. ЦАМ.
Износостойкое многослойное покрытие.
Крепление саморезами или стяжками.

Material of handles is zink. Resistant multi-layer plating.
Can fixing with normal self-tapping screws or with security tie screws.

160R



PB



AB



MBR



SN

405R



PB



SB



AB



SN

415R



PB



SN



Кор. 12 шт.
ctn. 12 pcs.

610R



AB

504R



PB



AB



AC



SN

Ручки на планке

Plate door handles



Литые ручки и планки. ЦАМ.
Износостойкое многослойное покрытие.
Крепление саморезами или стяжками.

Material of handles is zink. Resistant multi-layer plating.
Can fixing with normal self-tapping screws or with security tie screws.

160A

Сантехническая (Sanitary)



PB



AB



MBR



AC



SN

405A

Сантехническая (Sanitary)



PB



AB



SB



SN

504A

Сантехническая (Sanitary)



PB



AB



AC



SN

160M

Межкомнатные (interior)



PB



AB



MBR - остатки



Кор. 12 шт.
ctn. 12 pcs.

Литые ручки и планки. ЦАМ.
Износостойкое многослойное покрытие.
Крепление саморезами или стяжками.

Material of handles is zink. Resistant multi-layer plating.
Can fixing with normal self-tapping screws or with security tie screws.

405M



PB



AB



SN

504M



PB



MBR



SN

407M



SB



AC - остатки



Кор. 12 шт.
Стн. 12 pcs.

410M



PB/CP



AB



AC



SN (4 в наличии)

414M



PB



SB



AB



AC



SN

415M



PB



SB



AB



AC



SN

610M



PB1



AC



SB1



SN

Ручки на планке DAMX 55 мм

DAMX Plate door handles 55 mm



Литые ручки алюминий. Планка - сталь.
Износостойкое многослойное покрытие.
Крепление саморезами или стяжками.

The material of the handles is aluminum, the plates are steel.
Resistant multi-layer plating. Can fixing with normal self-tapping screws or with security tie screws.

405-55K

Межосевое (Center distance) - 55 мм.
L – левая(Left), R – правая (Right)

412-55K



PB



CP

форма
планки как у цвета PB



SN/CP



PB



CP

форма
планки как цвет PB



SN

405P



PB



SB/PB



AB



AC



BR



CP



SN/CP



Кор. 12 шт.
Ctn. 12 pcs.

405V



PB



SB/PB



AB



AC



BR



CP



SN/CP



Кор. 12 шт.
Ctn. 12 pcs.

Ручки на планке DAMX 55 мм

DAMX Plate door handles 55 mm

Литые ручки алюминий. Планка - сталь.
Износостойкое многослойное покрытие.
Крепление саморезами или стяжками.

The material of the handles is aluminum, the plates are steel.
Resistant multi-layer plating. Can fixing with normal self-tapping screws or with security tie screws.

405VP



PB



SB/PB



AB



AC



BR



AM



AS



CP



SN/CP



Кор. 12 шт.
Ctn. 12 pcs.

412VP



PB



SB/PB



AB



AC



BR



AS



AM



CP



SN/CP



Кор. 12 шт.
Ctn. 12 pcs.

Ручки на планке DAMX 55, 62 мм

DAMX Plate door handles 55, 62 mm



Литые ручки алюминий. Планка - сталь.
Износостойкое многослойное покрытие.
Крепление саморезами или стяжками.

The material of the handles is aluminum, the plates are steel.
Resistant multi-layer plating. Can fixing with normal self-tapping screws or with security tie screws.

412P

Межосевое
(Center distance) - 55 мм



Коп. 12 шт.
Ctn. 12 pcs.

412V

Межосевое
(Center distance) - 55 мм



Коп. 12 шт.
Ctn. 12 pcs.

405R

Межосевое
(Center distance) - 62 мм

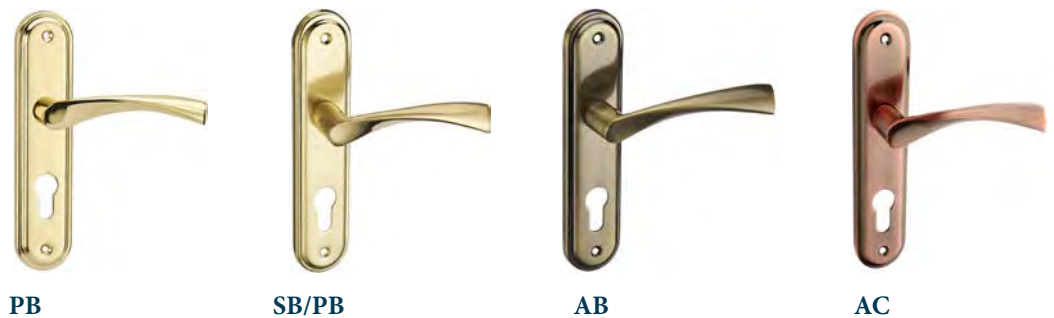

Ручки на планке DAMX 62-85 мм

DAMX Plate door handles 62-85 mm

Литые ручки алюминий. Планка - сталь.
Износостойкое многослойное покрытие.
Крепление саморезами или стяжками.

The material of the handles is aluminum, the plates are steel. Resistant multi-layer plating. Can fixing with normal self-tapping screws or with security tie screws.

405R Межосевое (Center distance) - 62 мм
продолжение
(continue)



SN/CP



BR



CP



AM



AS

412R Межосевое (Center distance) - 62 мм



PB



SB/PB



AB



AC



BR



AS



CP



AM



SN/CP



Коп. 12 шт.
Ctn. 12 pcs.

161L Межосевое (Center distance) - 85 мм



PB



SB/PB



AB



AC

Ручки на планке DAMX 85 мм

DAMX Plate door handles 85 mm



Литые ручки алюминий. Планка - сталь.
Износостойкое многослойное покрытие.
Крепление саморезами или стяжками.

The material of the handles is aluminum, the plates are steel. Resistant multi-layer plating. Can fixing with normal self-tapping screws or with security tie screws.

161L

продолжение
(continue)



BR



MBR



SN/CP



Коп. 12 шт.
ctn. 12 pcs.

162L



PB



SB/PB



AB



BR



MBR



AC



SN/CP



Коп. 12 шт.
ctn. 12 pcs.

163L



PB



SB/PB



AB



MBR



AC



SN/CP



Коп. 12 шт.
ctn. 12 pcs.

Ручки на планке DAMX 85 мм

DAMX Plate door handles 85 mm

Литые ручки алюминий. Планка - сталь.
Износостойкое многослойное покрытие.
Крепление саморезами или стяжками.

The material of the handles is aluminum, the plates are steel.
Resistant multi-layer plating. Can fixing with normal self-tapping screws or with security tie screws.

164L



300L



405L

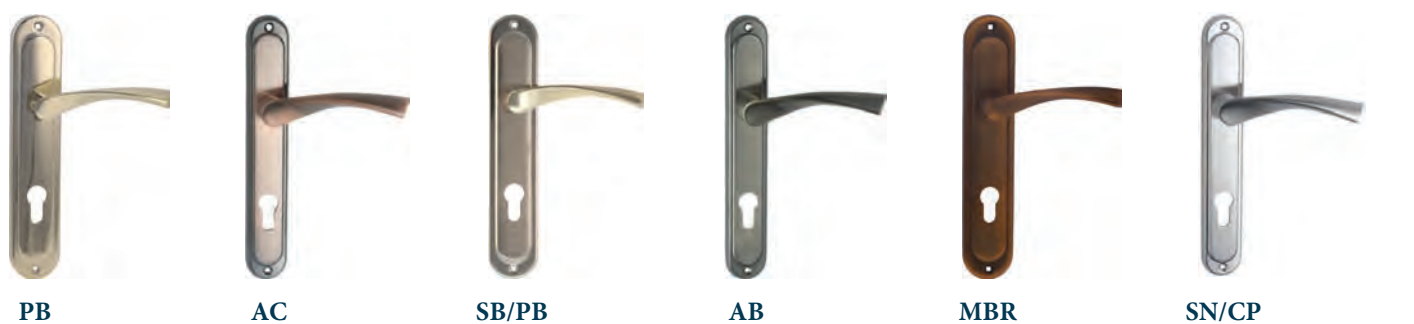

412L-F

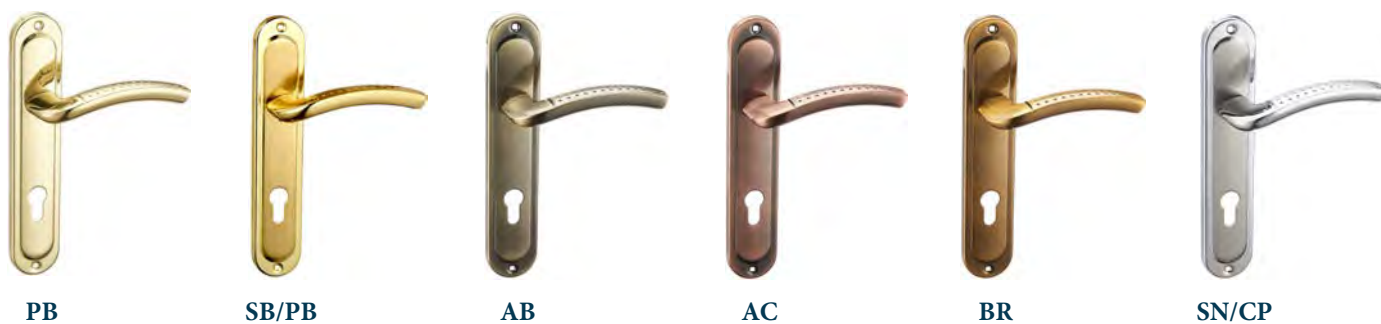

Ручки на планке DAMX 85 мм

DAMX Plate door handles 85 mm



Литые ручки алюминий. Планка - сталь.
Износостойкое многослойное покрытие.
Крепление саморезами или стяжками.

The material of the handles is aluminum, the plates are steel. Resistant multi-layer plating. Can fixing with normal self-tapping screws or with security tie screws.

412L



PB

SB/PB

AB

MBR

AC

SN/CP

412L-1



PB

SB/PB

AB

AC

BR

SN/CP

412L-C



PB

SB/PB

AB/BK

AC/BK

BR/BK

CP

SN/CP

443L



SB/PB

AB

AC

BR

SN

Ручки на планке DAMX 85 мм

DAMX Plate door handles 85 mm

Литые ручки алюминий. Планка - сталь.
Износостойкое многослойное покрытие.
Крепление саморезами или стяжками.

The material of the handles is aluminum, the plates are steel.
Resistant multi-layer plating. Can fixing with normal self-tapping screws or with security tie screws.

649L



PB SB AB AC BR CP SN/CP

650L



PB SB AB AC BR CP SN

654L



PB SB AB AC BR CP SN

Стяжки, квадраты

Tie screws, spindles

M3-R3 M4-R3

Стяжки для ручек на круглой накладке
(Tie-screws for round handles)

Упак. 25 пар
Ctn. 25 pcs.

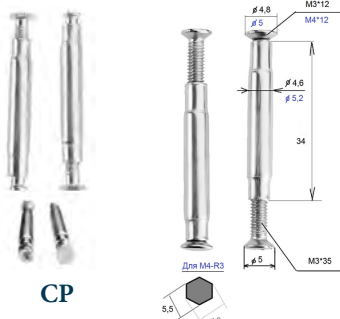

CP

SP

Квадраты
(Spindles)

- SP-100 мм
- SP-110 мм
- SP-105 мм
- SP-115 мм
- SP-120 мм
- SP-140 мм
- SP-150 мм



Упак. 10 пар
Ctn. 10 pcs.

Ручки защелки



Z102-R

С ключом
(With key)



Кор. 12 шт.
ctn. 12 pcs.

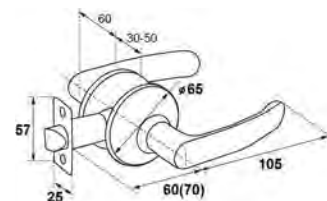

Z102-A

Сантехническая
(Sanitary)



Кор. 12 шт.
ctn. 12 pcs.

Z102-M

Межкомнатная
(interior)



Кор. 12 шт.
ctn. 12 pcs.

Механизмы (Mechanism)

L60/70 R

К защелкам «Z»
(For the latch «Z»)



Z103-R

С ключом
(With key)

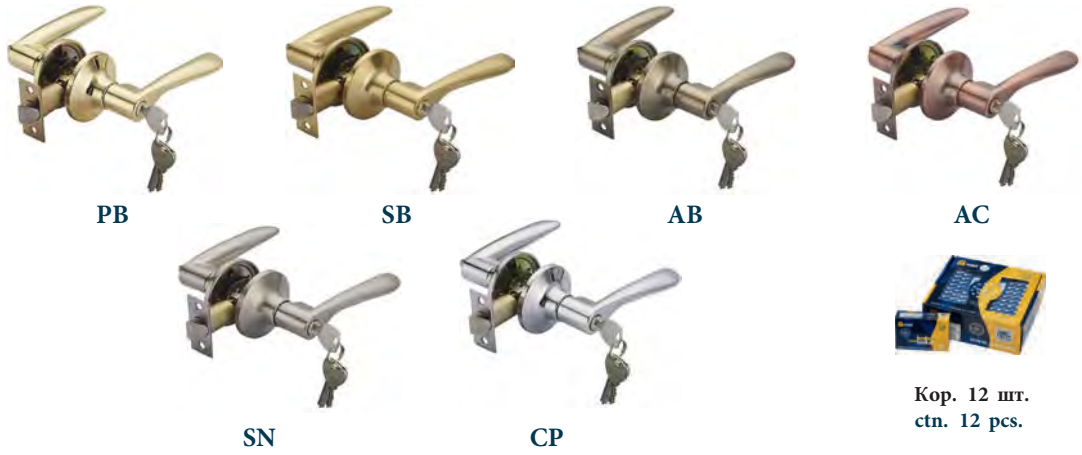

Кор. 12 шт.
ctn. 12 pcs.

Z103-A

Сантехническая
(Sanitary)



Z109-R

С ключом
(With key)

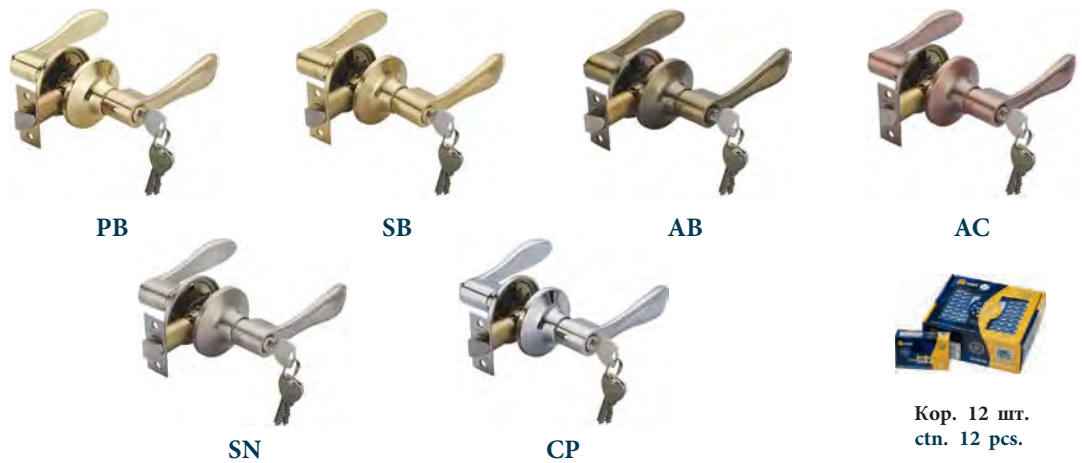

Кор. 12 шт.
ctn. 12 pcs.

Z109-A

Сантехническая
(Sanitary)

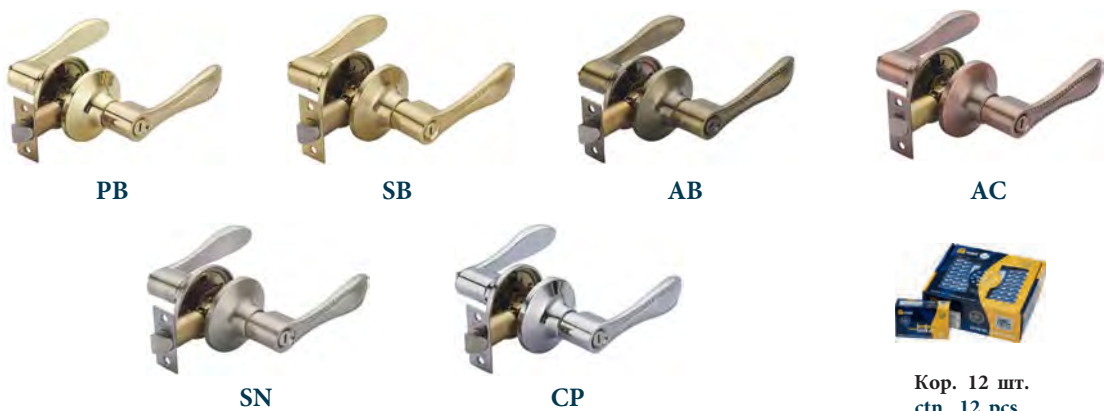

Кор. 12 шт.
ctn. 12 pcs.

Ручки защелки

Latch Handles



Z110-R

С ключом
(With key)



PB

SB

AB



AC

SN



Коп. 12 шт.
ctn. 12 pcs.

Z110-A

Сантехническая
(Sanitary)



PB

AB

AC

SN

Z110-M

Межкомнатная
(interior)



AB

PB

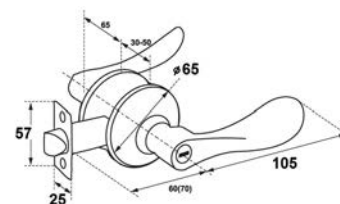

Z111-R

С ключом
(With key)



PB

SB

AB

AC



CP

SN



Коп. 12 шт.
ctn. 12 pcs.

Z111-A

Сантехническая
(Sanitary)

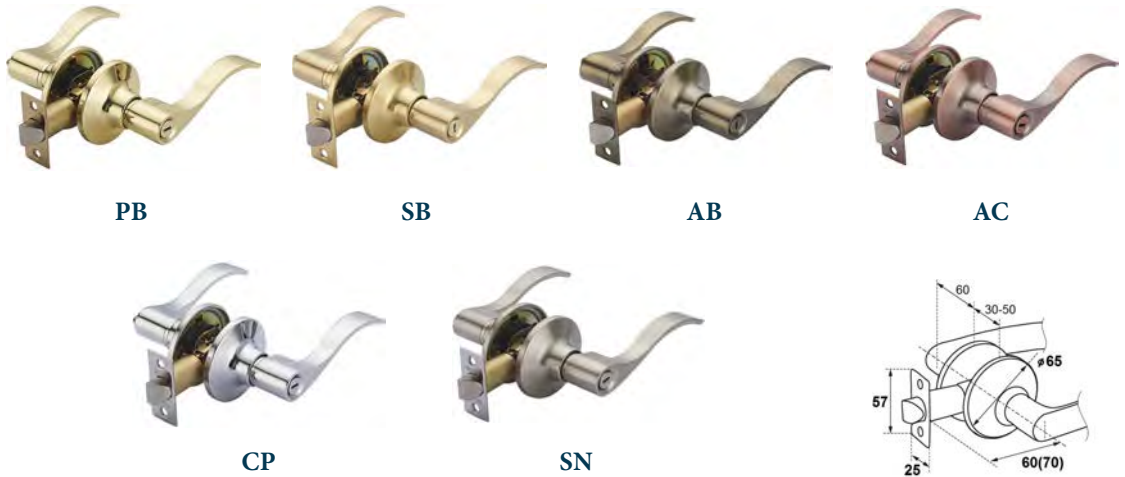

Z112-R

С ключом
(With key)

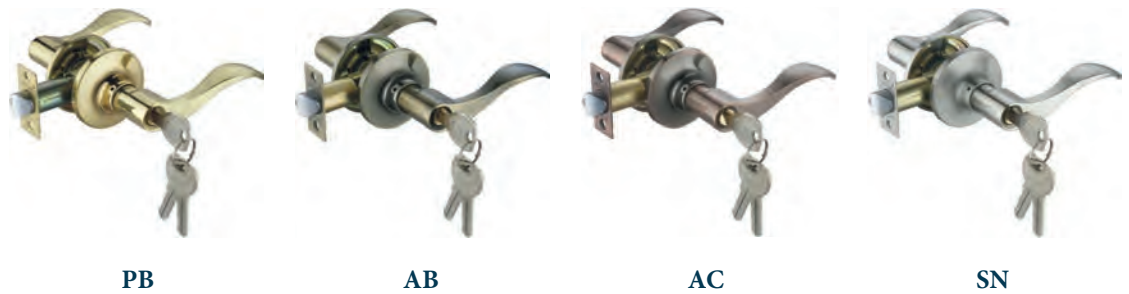

Z112-A

Сантехническая (Sanitary)

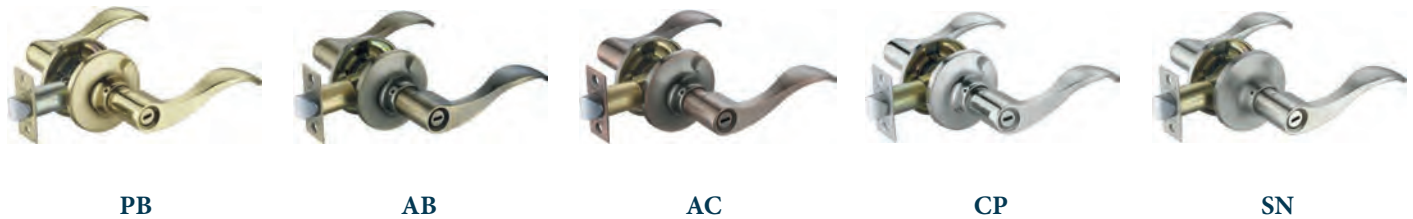

Z112-M

Межкомнатная
(interior)



Кор. 12 шт.
ctn. 12 pcs.

Z410-A

Сантехническая
(Sanitary)



Ручки защелки

Z410-R

С ключом
(With key)



PB/SB

SB

AB/CP

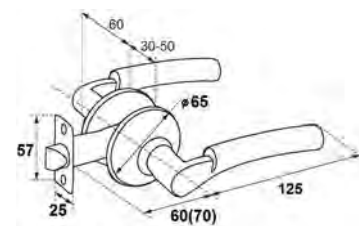

AB/PB

SN/CP

AC



Кор. 12 шт.
ctn. 12 pcs.

Z410-M

Межкомнатная
(interior)



PB/SB

AC

AC/CP

SN/CP



Кор. 12 шт.
ctn. 12 pcs.

распродажа, кроме SN/CP

Z411-R

С ключом
(With key)



PB

SB

AB



AC

CP

SN



Кор. 12 шт.
ctn. 12 pcs.

Z2-M

Межкомнатная
(interior)



WH



Кор. 12 шт.
ctn. 12 pcs.

Z411-A

Сантехническая
(Sanitary)



PB

SB

AB



AC

CP

SN

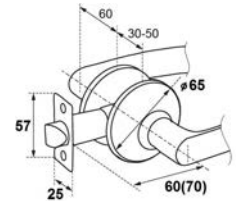

Z1-R

С ключом
(With key)



PB

SB

AB

AC



RW

BW

SN



Кор. 20 шт.
ctn. 20 pcs.

Z1-A

Сантехническая
(Sanitary)



PB

SB

AB

AC



BW

RW

SN

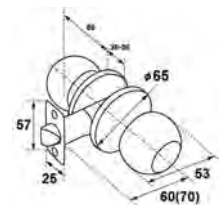

Ручки защелки

Z1-M

Межкомнатная
(interior)



PB



SB



AB



AC



BW



RW



SN



MRW

распродажа



Кор. 20 шт.
ctn. 20 pcs.

Z4-R

С ключом
(With key)



PB



SN

Z4-M

Межкомнатная
(interior)



SB



Кор. 20 шт.
ctn. 20 pcs.

Ручки защелки DAMX DAMX Latch Handles



Z1-R

С ключом (With key)



PB



SB



AB



AC



SN



CP

Z1-A

Сантехническая
(Sanitary)



PB



SB



AB



AC



SN



CP

Z1-M

Межкомнатная
(interior)



PB



SB



AB



AC



SN



CP

Z6-R

AC - остатки, распродажа



Ручки защелки DAMX

DAMX Latch Handles

Z100- A

Сантехническая
(Sanitary)



PB



AB



CP



SN

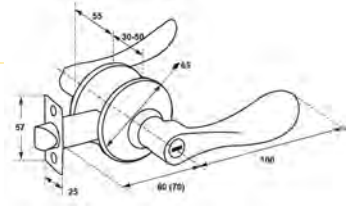

Z100-R

С ключом
(With key)



PB



AB



CP



SN

Z110- A

Сантехническая
(Sanitary)



PB



AB



CP



SN

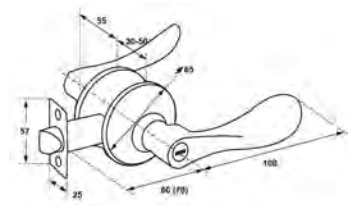

Z110-R

С ключом
(With key)



PB



AB



CP



SN

Ручки защелки DAMX

DAMX Latch Handles

Z405-A

Сантехническая
(Sanitary)



PB



AB



CP



SN

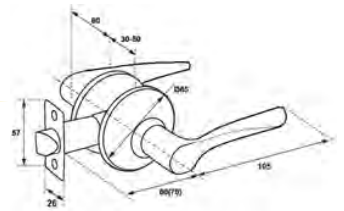

Z405-R

С ключом
(With key)



PB



AB



CP



SN

DAMX

Z412-A

Сантехническая
(Sanitary)



PB



AB



CP



SN

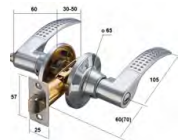

Z412-R

С ключом
(With key)



PB



AB



CP



SN

L60/70D R



PB



AB



AC

67-3



SN

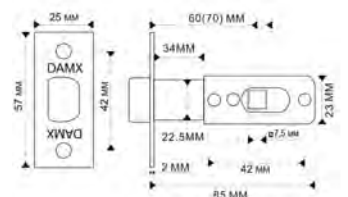

Ручки скобы «В»

Pull handles «B»



B400

Материал ручек ЦАМ
Material of handles is zink

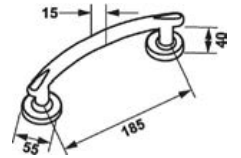

B405

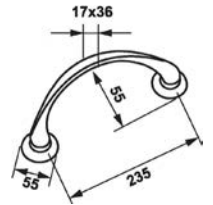

B418

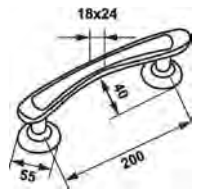

B419

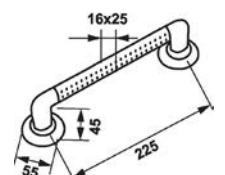

B434

Материал ручек ЦАМ
Material of handles is zink



PB



SB



AB



BR



SN

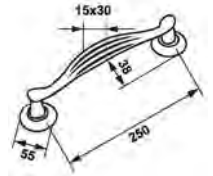

B435

Межосевое расстояние - 245 мм
Center distance - 245 mm



PB



SB



BR



AB



AC



SN

B425

Межосевое расстояние - 250 мм
Center distance - 250 mm



MBR

B720

Межосевое расстояние - 245 мм
Center distance - 245 mm



MBR

B730

Межосевое расстояние - 250 мм
Center distance - 250 mm



MBR

B371



PB/SB



MAB



MBR



SN/CP

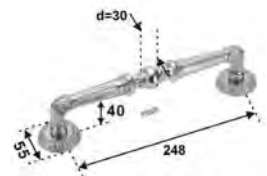

B424



PB/SB



MAB



MBR



SN/CP



B497



PB/SB



MAB



MBR



SN/CP

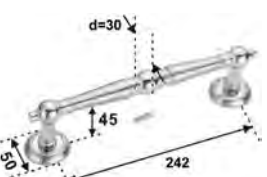

B498



PB/SB



MAB



MBR



SN/CP



B499

Материал ручек ЦАМ
Material of handles is zink



PB/SB



MAB



MBR



SN/CP



B650



PB/SB



MAB



MBR



SN/CP



B690



PB/SB



MAB



MBR



SN/CP



B691

Межосевое расстояние - 245 мм
Center distance - 245 mm



PB/SB



MAB



MBR



BSN/GR



SN/CP

B692



PB/SB



MAB



MBR



SN/CP



B693



PB/SB



MAB



MBR



SN/CP

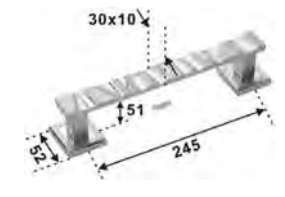

B694



PB/SB



MAB



MBR



SN/CP

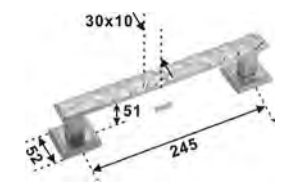

Ручки скобы «В»

Pull handles «B»



B695

Материал ручек ЦАМ
Material of handles is zink



PB/SB



MAB



MBR



SN/CP

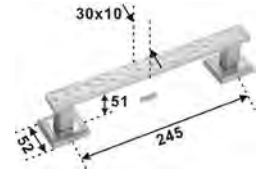

B696



PB/SB



MAB



MBR



SN/CP



B697

Межосевое расстояние - 248 мм
Center distance - 248 mm



PB/SB



MAB



MBR



BSN/GR



SN/CP

B698



PB/SB



MAB



MBR



SN/CP



B699



PB/SB



MAB



MBR



SN/CP



B721



PB/SB



MAB



MBR



SN/CP



B722



PB/SB



MAB



71

MBR



SN/CP

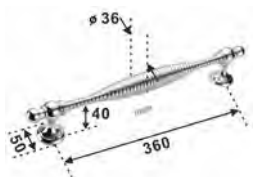

B723

Материал ручек ЦАМ
Material of handles is zinc



PB/SB



MAB



MBR



SN/CP

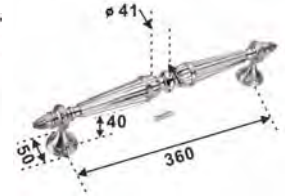

B724



PB/SB



MAB



MBR



SN/CP

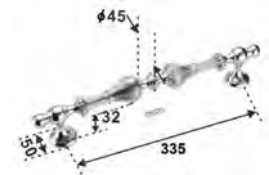

B725



PB/SB



MAB



MBR



SN/CP

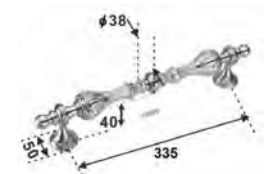

B801



PB/SB



MAB



MBR



SN/CP

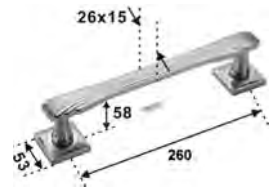

B904



PB/SB



MAB



MBR



SN/CP



B999



PB/SB



MAB



MBR



BSN/GR



SN/CP



Коп. 12 шт.
ctn. 12 pcs.



Ручки скобы «В»

Pull handles «B»

Нержавеющая сталь
(Stainless steel)

BS1



Наименование (Item name)	Размеры (size), см		Цвета (color)
	A	D	
BS1-18	17,5	2,5	CP, BR, GP, WH
BS1-20	20	2,5	SN/CP, SN
BS1-30	30	3,2	CP, SN/CP, SN
BS1-32	31-32	3,2	CP, SN

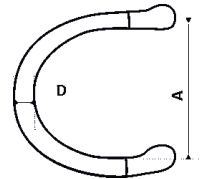

BS2



Наименование (Item name)	Размеры (size), см		Цвета (color)
	A	D	
BS2-30	30	32	SN, CP
BS2-39	38,5	3,2	WH, BR, GP
BS2-40	40	3,2	CP, SN

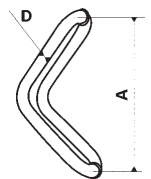

BS3

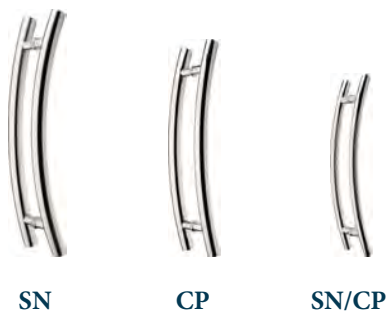

Наименование (Item name)	Размеры (size), см			Цвета (color)
	A	D	B	
BS3-30	30	2,5	44	SN, SN/CP, CP
BS3-44	44	3,8	60	SN, CP
BS3-45	45	3,8	60	CP, SN/CP
BS3-60	60	3,8	70	SN/CP

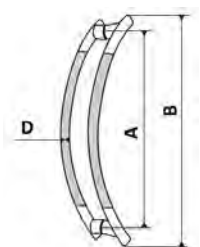

BS4



Наименование (Item name)	Размеры (size), см		Цвета (color)
	A	D	
BS4-30	30	3,2	SN, BR, CP, WH, GR, BG, BK
BS4-40	40	3,8	SN, CP
BS4-45	45	3,8	SN
BS4-57	56	3,8	SN, CP
BS4-60	60	3,8	CP
BS4-42	41,5	3,8	SN, CP
BS4-80	80	3,8	SN, CP

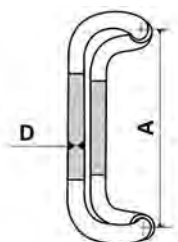

Нержавеющая сталь
(Stainless steel)

BS5



CP



SN



SN/CP

Наименование (Item name)	Размеры (size), см		Цвета (color)
	A	D	
BS5-30	30	3,2	CP, SN, SN/CP
BS5-45	45	3,8	CP, SN/CP
BS5-56	56	3,8	CP, SN/CP
BS5-60	60	3,8	CP, SN, SN/CP
BS5-20	20	2,5	CP, SN
BS5-80	80	3,8	CP, SN

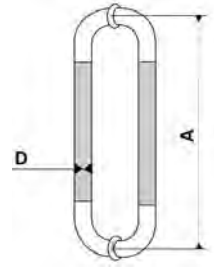

BS6



CP



SN/CP



GP



BR

Наименование (Item name)	Размеры (size), см		Цвета (color)
	A	D	
BS6-27	27	3,2	GP, WH
BS6-30	30	3,2	CP, SN/CP, SN, BR
BS6-42	42	3,8	SN/CP
BS6-45	45	3,8	SN/CP, CP
BS6-56	57.5	3,8	SN/CP, CP
BS6-60	60	3,8	SN

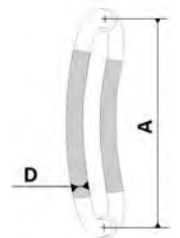

Кор. 10 шт.
ctn. 10 pcs.

BS7



SN/CP



SN



CP

Наименование (Item name)	Размеры (size), см			Цвета (color)
	A	D	B	
BS7-20	20	2,5	30	SN
BS7-30	30	3,2	42	SN, SN/CP, CP
BS7-45	45	3,2	60	SN/CP, CP
BS7-60	60	3,2	80	SN/CP, CP, SN
BS7-80	80	3,8	1200	SN/CP, CP, SN

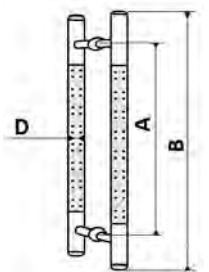

Кор. 10 шт.
7-80 - Кор. 6 шт.
ctn. 6 pcs.

BS7-30-1

SN, CP - Аналог BS 7-30, но диаметр 38 мм



BS7-30-2

SN, CP - Аналог BS 7-30, но без точек на ручке

Кор. 10 шт.
ctn. 10 pcs.

Ручки скобы «BS»

Pull handles «BS»



Нержавеющая сталь
(Stainless steel)

BS8



CP

SN/CP

Наименование (Item name)	Размеры (size), см			Цвета (color)
	A	D	B	
BS8-20	20	3,2	30	SN, CP
BS8-30	30	3,2	45	SN, CP
BS8-40	40	3,8	60	SN, CP
BS8-45	45	3,8	60	SN, CP
BS8-60	60	3,8	80	CP

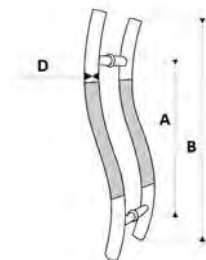

Кор. 10 шт.
ctn. 10 pcs.

BS9



SN

CP

SN/CP

Наименование (Item name)	Размеры (size), см			Цвета (color)
	A	D	B	
BS9-20	20	2,5	30	SN
BS9-30	30	3,2	60	SN, CP, SN/CP
BS9-50	50	3,8	80	CP, SN/CP
BS9-60	60	3,8	100	CP, SN/CP
BS9-80	80	3,8	120	SN/CP

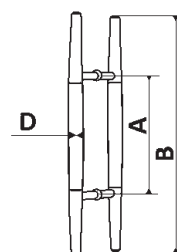

Кор. 10 шт.
ctn. 10 pcs.

BS10-40, BS10-60, BS10-80

SN



Наименование (Item name)	Размеры (size), см		
	A	D	B
BS10-40	40	38	60
BS10-60	60	38	80
BS10-80	80	38	120

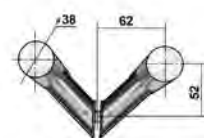

Кор. 10 шт.
ctn. 10 pcs.

BS12-40, BS12-60, BS12-80

SN



Наименование (Item name)	Размеры (size), см		
	A	D	B
BS12-40	40	38	60
BS12-60	60	38	80
BS12-80	80	38	120

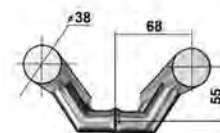

Кор. 10 шт.
ctn. 10 pcs.

Нержавеющая сталь
(Stainless steel)

BS13-40, BS13-60, BS13-80

SN

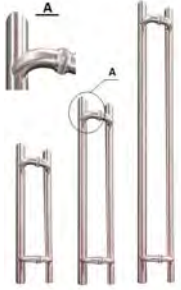

Наименование (Item name)	Размеры (size), см		
	A	D	B
BS13-40	40	38	60
BS13-60	60	38	80
BS13-80	80	38	120

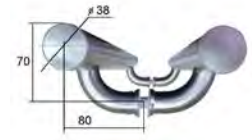

Кор. 10 шт.
ctn. 10 pcs.

BS14-40, BS14-60, BS14-80

SN



Наименование (Item name)	Размеры (size), см		
	A	D	B
BS14-40	40	38	60
BS14-60	60	38	80
BS14-80	80	38	120

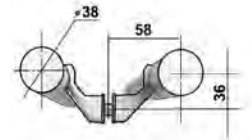

Кор. 10 шт.
ctn. 10 pcs.

BS20-20, BS20-20/20, BS20-30, BS20-40

SN



Наименование (Item name)	Размеры (size), см	
	A	D
BS20-20	20	19
BS20-20-22	20	22
BS20-30	30	25
BS20-40	40	25

BS21-20/40, BS21-20/40-22

SN

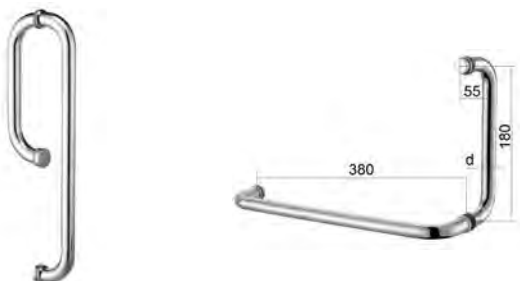

Кор. 10 шт.
ctn. 10 pcs.

Механизмы врезные Mortise latches



D45

Задвижка
(Door bolt)

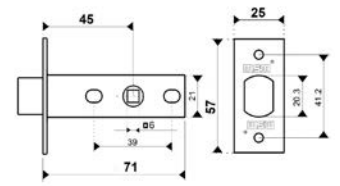
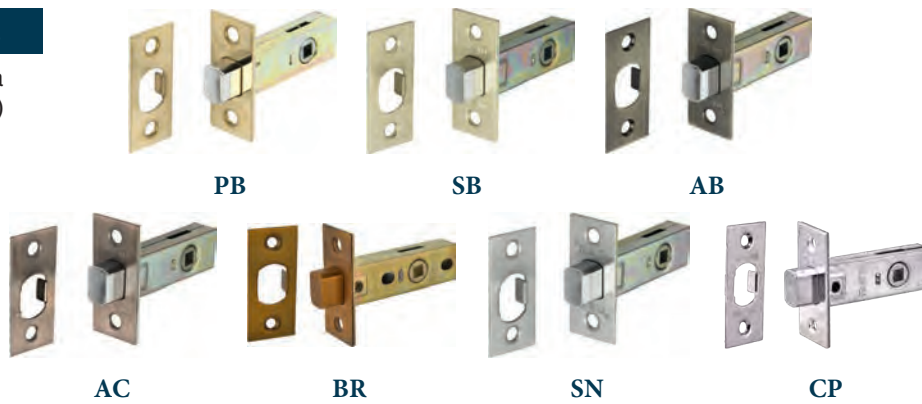

Кор. 120 шт. / Уп. 12 шт.
Ctn. 120 pcs / bo x 12 pcs.

D48

Задвижка
(Door bolt)

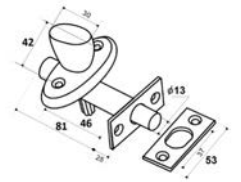
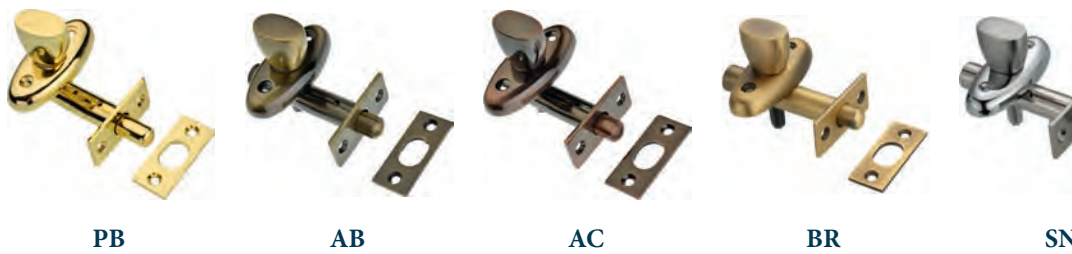

L45

Защелка
(The latch)

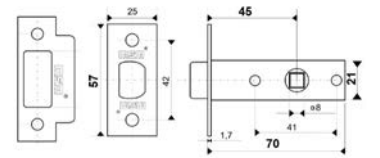

Кор. 120 шт. / Уп. 12 шт.
Ctn. 120 pcs / bo x 12 pcs.

L45P

Пластиковый
язычок (Plastic latch)

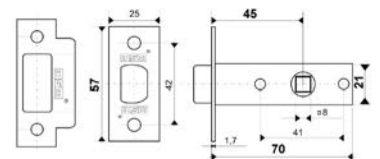
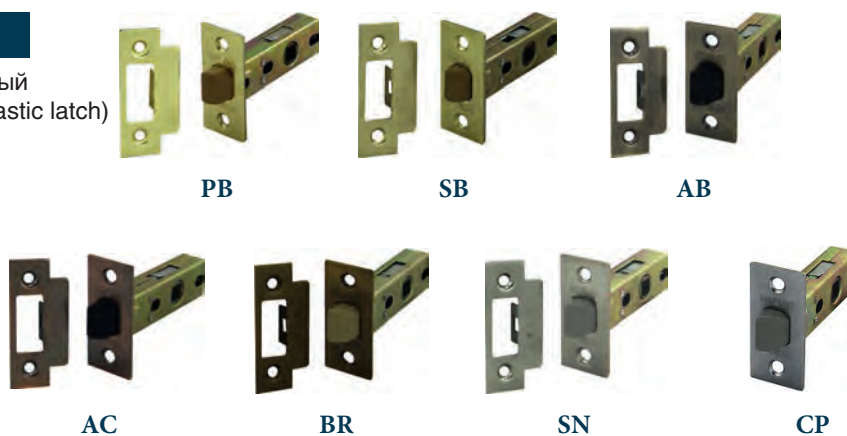

Кор. 120 шт. / Уп. 12 шт.
Ctn. 120 pcs / bo x 12 pcs.

L47

Сантехнический
(Sanitary)

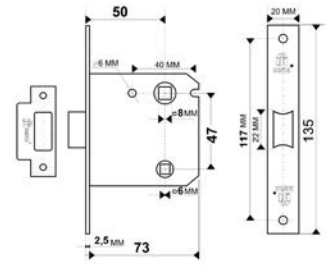

Кор. 60 шт. / Уп. 5 шт.
Ctn. 60 pcs / box 5 pcs.

L70

Сантехнический
(Sanitary)

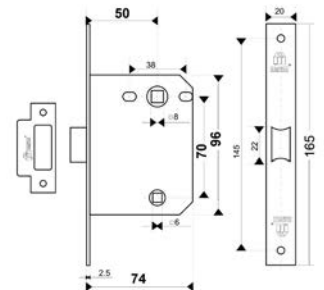

Кор. 40 шт. / Уп. 5 шт.
Ctn. 40 pcs / box 5 pcs.

L70P

Сантехнический
пластиковый язычок
(Sanitary Plastic
latch)

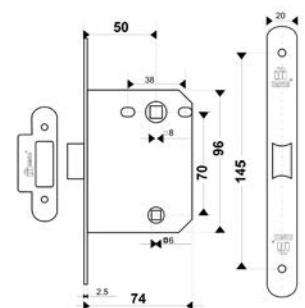
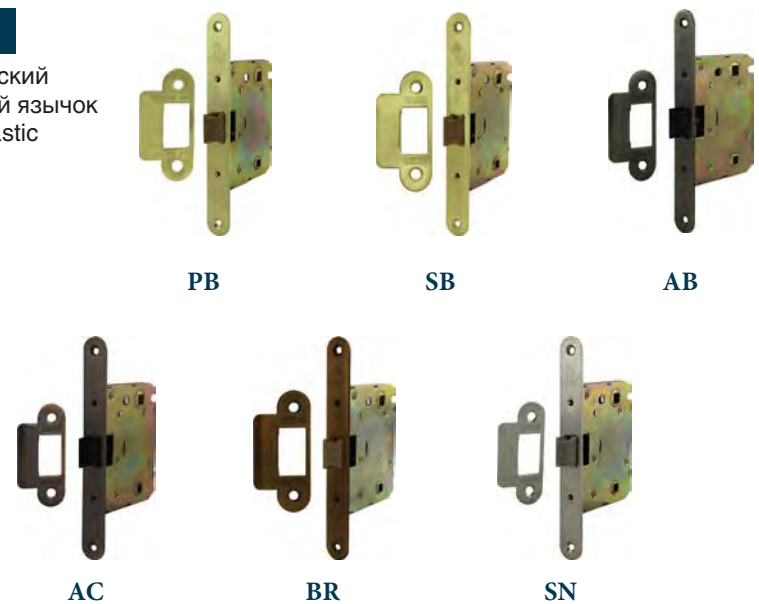

Кор. 40 шт. / Уп. 5 шт.
Ctn. 40 pcs / box 5 pcs.

Механизмы врезные Mortise latches



L90T

Сантехнический
(Sanitary)



PB

SB

AB

AC

SN

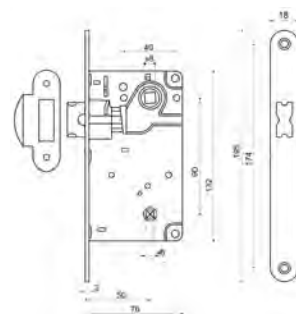

Коп. 30 шт. / Уп. 5 шт.
Ctn. 30 pcs / box 5 pcs.

L96P

Сантехнический
пластиковый
язычок
(Sanitary Plastic
latch)



PB

SB

AB

AC

SN

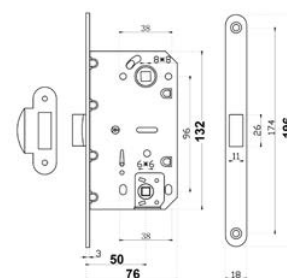

Коп. 30 шт. / Уп. 5 шт.
Ctn. 30 pcs / box 5 pcs.

Механизмы врезные DAMX DAMX Mortise latches



L45D

Защелка
(Latch)



AC

PB

SB

AB

BR

SN

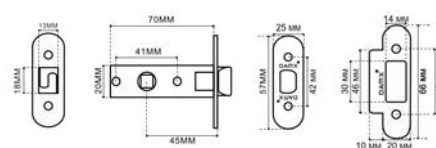

Коп. 120 шт. / Уп. 12 шт.
Ctn. 120 pcs / box 12 pcs.

L70D

Сантехнический
(Sanitary)

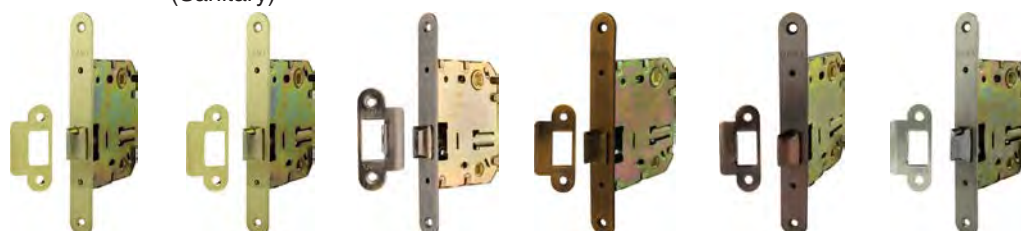

PB

SB

AB

BR

AC

SN

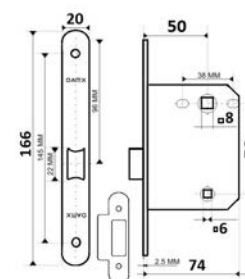

Коп. 30 шт. / Уп. 5 шт.
Ctn. 30 pcs / box 5 pcs.

L70D-S Сантехнический (Sanitary)

Механизмы врезные DAMX DAMX Mortise latches



PB



AB



SN

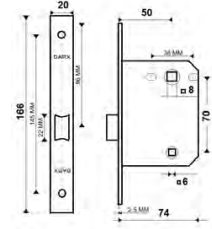

Кор. 40 шт. / Уп. 5 шт.
Ctn. 40 pcs / box 5 pcs.

L50M

Задвижка (Door bolt)



PB



AB



SN

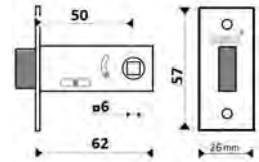

Кор. 72 шт. / Уп. 12 шт.
Ctn. 72 pcs / box 12 pcs.

L55M

Задвижка (Door bolt)



PB



SB



AB

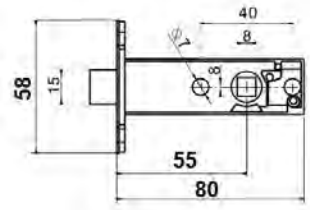

Кор. 72 шт. / Уп. 12 шт.
Ctn. 72 pcs / box 12 pcs.



AC



BR



SN

L70M

Сантехнический (Sanitary)



PB



SB



AB



AC



SN

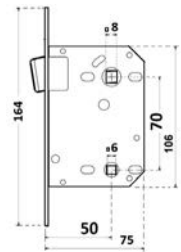

Кор. 40 шт. / Уп. 5 шт.
Ctn. 40 pcs / box 5 pcs.

L90M

Сантехнический (Sanitary)



PB



SB



AB



80 AC



BR



SN

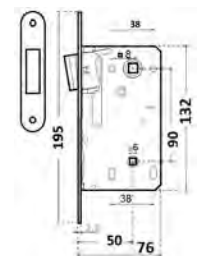

Кор. 30 шт. / Уп. 5 шт.
Ctn. 30 pcs / box 5 pcs.

Магнитные замки

Magnetic lock body



L95MI

Сантехнический
(Sanitary)



PB

SB

AB

AC

SN

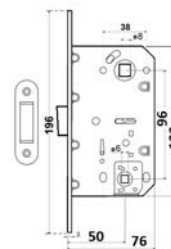

Кор. 30 шт. / Уп. 5 шт.
Ctn. 30 pcs / box 5 pcs.

ML85M



PB

SB

AB

AC

SN

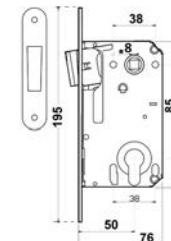

Кор. 30 шт. / Уп. 5 шт.
Ctn. 30 pcs / box 5 pcs.

ML85MI



PB

SB

AB

AC

SN

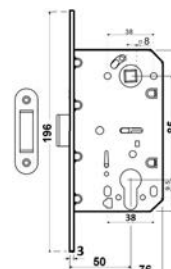

Кор. 30 шт. / Уп. 5 шт.
Ctn. 30 pcs / box 5 pcs.

ML90MK

цена снижена !



PB

SB

AB

AC

SN

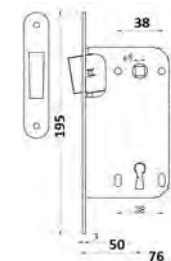

Кор. 40 шт. / Уп. 5 шт.
Ctn. 40 pcs / box 5 pcs.

M45KR

Крестовой ключ
(Cross key lock)



PB



SN



Кор. 30 шт. / Уп. 5 шт.
Ctn. 30 pcs / box 5 pcs.

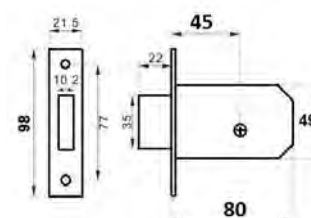

M50KR

Крестовой ключ
(Cross key lock)



PB



AB



SN



Кор. 30 шт. / Уп. 5 шт.
Ctn. 30 pcs / box 5 pcs.

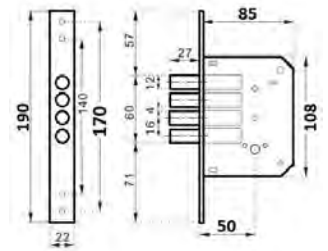

M50KR-T

Крестовой ключ
(Cross key lock)



PB



AB



SN



Кор. 30 шт. / Уп. 5 шт.
Ctn. 30 pcs / box 5 pcs.

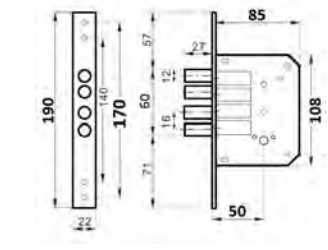

M50

Крестовой ключ
(Cross key lock)



PB



AB



SN



Кор. 30 шт. / Уп. 5 шт.
Ctn. 30 pcs / box 5 pcs.

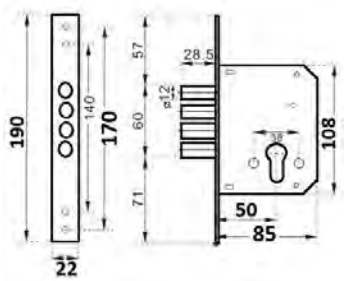

ML55P

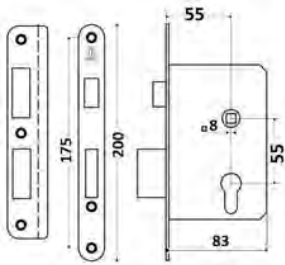

ML55V

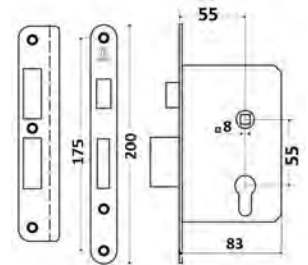

PB



SB



AB



PB



SB



AB - нет



BR



AC



Кор. 30 шт. / Уп. 5 шт.
Ctn. 30 pcs / box 5 pcs.



BR



AC

Врезные замки

ML62



PB



SB



AB



AC



BR



SN

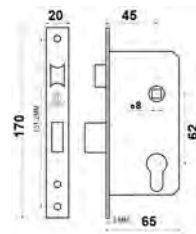

Кор. 30 шт. / Уп. 5 шт.
Ctn. 30 pcs / box 5 pcs.

ML85

БК, WH - новые цвета, ожидаем июль 24 г.



PB



SB



AB



AC



BR



SN

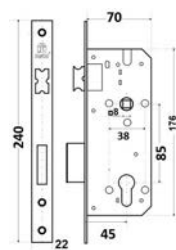

Кор. 30 шт. / Уп. 5 шт.
Ctn. 30 pcs / box 5 pcs.

ML85B



PB



SB



AB



AC



BR



GR

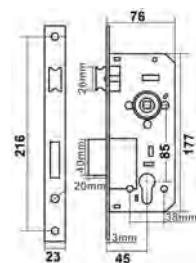

CP



SN



BK/PB



BK/CP



WH/PB



WH/CP



Кор. 30 шт. / Уп. 5 шт.
Ctn. 30 pcs / box 5 pcs.

ML85D

Left, Right



SN



SB



Кор. 10 шт
Ctn. 10 pcs

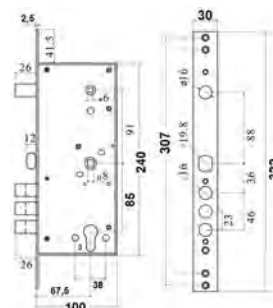

ML85A



PB

SB

AB

AC



BR

CP

SN

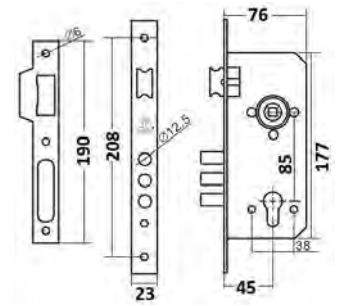

Кор. 30 шт. / Уп. 5 шт.
Ctn. 30 pcs / box 5 pcs.

ML85T



PB

SB

AB

AC

SN

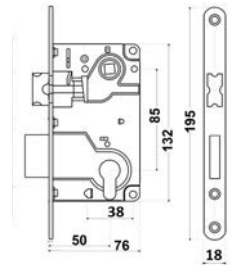

Кор. 30 шт. / Уп. 5 шт.
Ctn. 30 pcs / box 5 pcs.

ML85P



PB

SB

AC

SN

AB

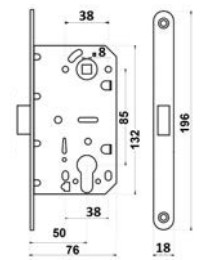

Кор. 30 шт. / Уп. 5 шт.
Ctn. 30 pcs / box 5 pcs.

ML80/60 D Новинка



SB

AB

BSN

SN

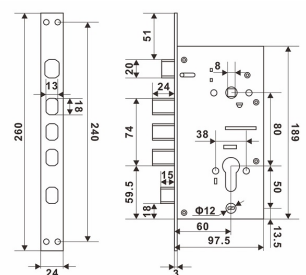

Кор. 10 шт
Ctn. 10 pcs

RL12B BK

Для дверей открывающихся внутрь !



Кор. 20 шт
Ctn. 20 pcs

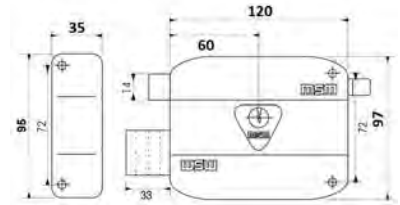

RL14B BK

Для дверей открывающихся внутрь !



Кор. 20 шт
Ctn. 20 pcs

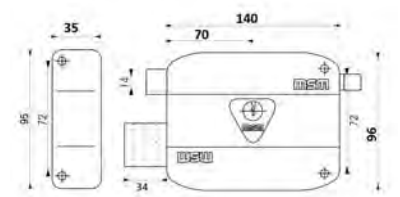

RL14B-W BK

Для дверей открывающихся внутрь !



Кор. 20 шт
Ctn. 20 pcs

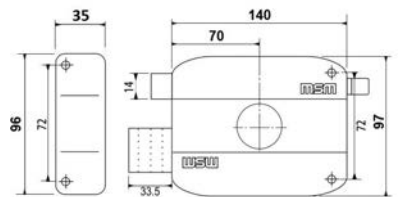

Замок накладной DAMX

DAMX Rim lock



RL12-I GR

Универсальный! Защелка переставляется.



Кор. 24 шт
Ctn. 24 pcs

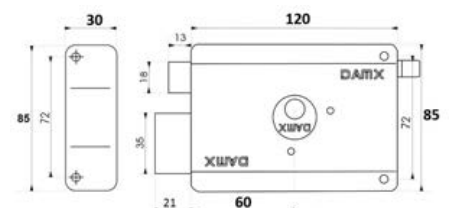

Фурнитура для китайских металлических дверей

KT1-A

Универсальная
(Universal)



SN



Кор. 12 шт
Ctn. 12 pcs

KT2-A

Автоматическое
запирание
(Locking without a key)



SN

KT3-A

Автоматическое
запирание
(Locking without a key)



SN

KT2-CAL

Автоматическое
запирание
(Locking without a key)

L - левый (left)
R - правый (right)



Кор. 12 шт
Ctn. 12 pcs

KT2-CAR



SN

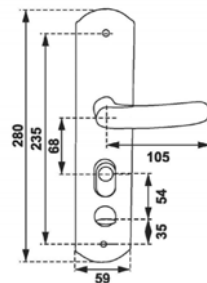

ML68/60



CP

ML68/60T

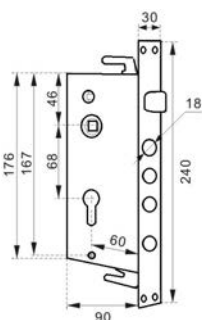

толстый металл
(thick metal)



CP

ML68/60A

Автоматическое
запирание
(Locking without a key)



Кор. 20 шт. / Уп. 5 шт.
Ctn. 20 pcs / box 5 pcs.

L - левый (left)
R - правый (right)



CP

ML68/60K

Круглый ригель
(Round bolt)



CP

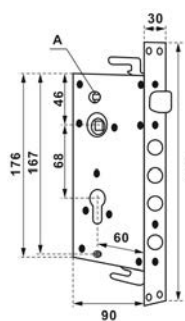

ML68/60KA

Круглый ригель
(Round bolt)
Автоматическое
запирание
(Locking without a key)



Кор. 20 шт. / Уп. 5 шт.
Ctn. 20 pcs / box 5 pcs.

L - левый (left)
R - правый (right)



CP

KT4-AL AB



Автоматическое
 запирание
 (Locking without a key)
 L - левый (left)
 R - правый (right)



Кор. 12 шт.
 Ctn. 12 pcs

KT4-AR AB



KT4G-AL AM



Металл- 3 мм

KT4G-AR AM



L - левый (left)
 R - правый (right)

KT4G-AL BK



L - левый (left)
 R - правый (right)



Кор. 12 шт.
 Ctn. 12 pcs

KT4G-AR BK



KT4G-AL

L - левый (left)
 R - правый (right)

KT4G-AR



AS



GR



SN



AB - ожидаем приход

F102



PB

WH

CP

SN

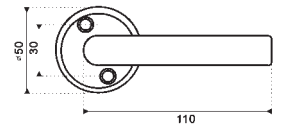

Кор. 60 шт. / Уп. 10 шт.
Ctn. 60 pcs / box x 10 pcs.

RW1-F



PB

SN

WH

CP

Кор. 200 шт. / Уп. 20 шт.
Ctn. 200 pcs / box x 20 pcs.

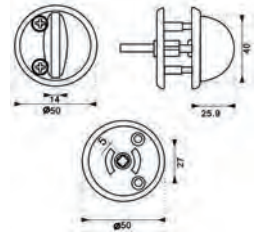

R1-F

50 мм
(Cylinder Plate)



PB

SN

WH

CP

Кор. 200 шт. / Уп. 25 шт.
Ctn. 200 pcs / box x 25 pcs.



R1-FB

55 мм
(Cylinder Plate)



PB

CP

Кор. 200 шт./Уп. 25 шт.
Ctn. 200/bo x 25 pcs.

R1-KF

(Key Plate)

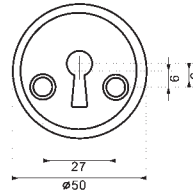

PB

CP



WH

SN

ML72F

Замок
(locks)



PB

SN

CP

WH

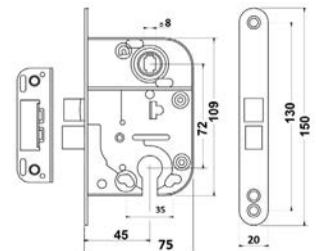

Кор. 40 шт. / Уп. 5 шт.
Ctn. 40 pcs / box x 5 pcs.

L72F

Механизм
(Mortise latch)



PB

SN

CP

WH

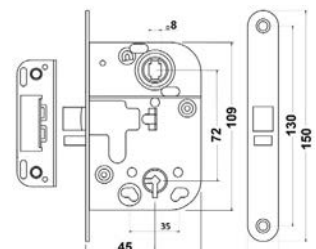

Кор. 40 шт. / Уп. 5 шт.
Ctn. 40 pcs / box x 5 pcs.

Фурнитура для раздвижных дверей

F1

Петля (Hinges)



WH



PN

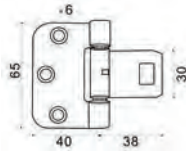

Кор. 160 шт. / Уп. 20 шт.
Ctn. 160 pcs / box 20 pcs.

F2

Петля (Hinges)



PN



WH

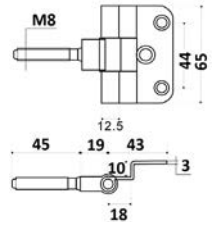

RD4

Ролики (Door wheel)

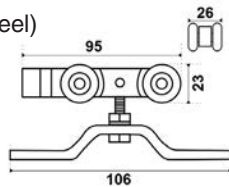

Кор. 20 шт. / Уп. 5 шт.
Ctn. 20 pcs / box 5 pcs.

RD8

Ролики (Door wheel)

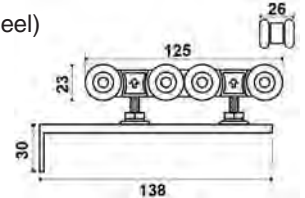

H1

Верхняя направляющая
(Upper guide rail)



H1-2 - 2 м
H1-3 - 3 м

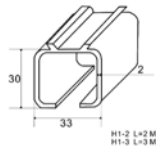

Уп. 4 шт.
Ctn. 4 pcs

H2

Верхняя направляющая
(Lower guide rail)



1 метр

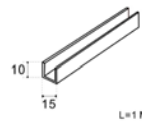

Уп. 10 шт.
Ctn. 10 pcs

H3

Кронштейн
(corner)

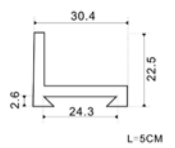

Уп. 50 шт.
Ctn. 50 pcs

DS-50

Механизм
(Mortise latch)

Кор. 40 шт. / Уп. 5 шт.
Ctn. 40 pcs / box 5 pcs.



PB



SB



AB



AC



BR



SN

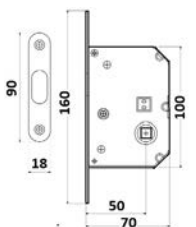

MS-50

Замок
(lock body)

Кор. 40 шт. / Уп. 5 шт.
Ctn. 40 pcs / box 5 pcs.



PB



SB



AB



AC



BR



SN

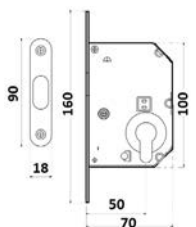

RS1-M Межкомнатная (Interior)

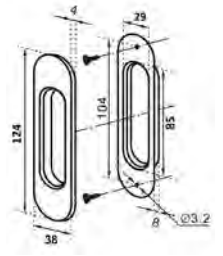
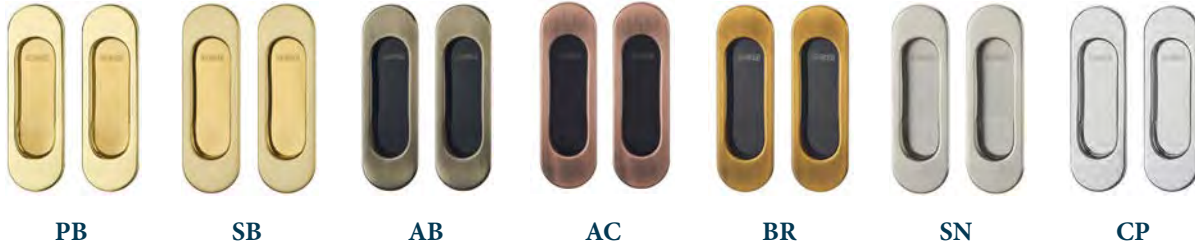

Коп. 30 шт. / Уп. 5 шт.
Ctn. 30 pcs / box 5 pcs.

RS1-A Сантехническая (Sanitary)

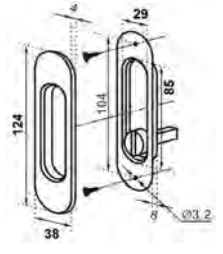
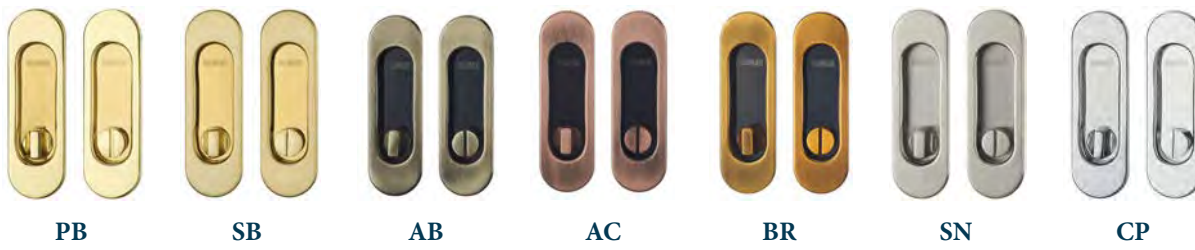

Коп. 30 шт. / Уп. 5 шт.
Ctn. 30 pcs / box 5 pcs.

RS1-R Под замок (For lock body)

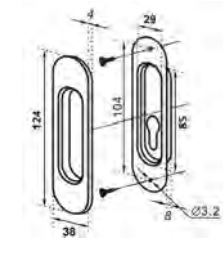
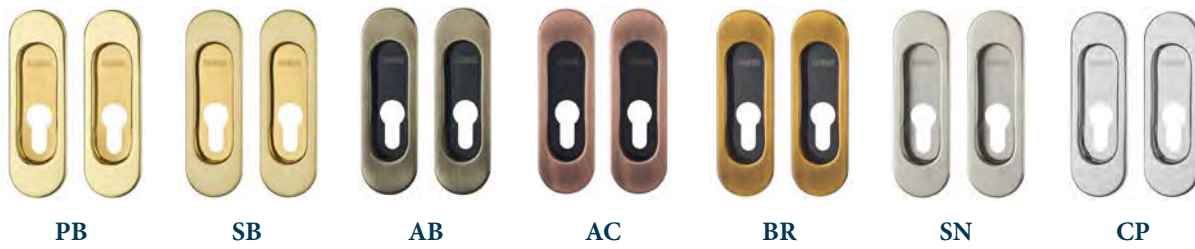

Коп. 30 шт. / Уп. 5 шт.
Ctn. 30 pcs / box 5 pcs.

SS1-M Межкомнатная (Interior)

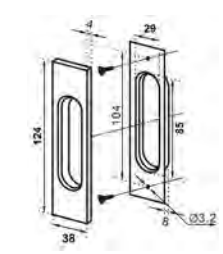
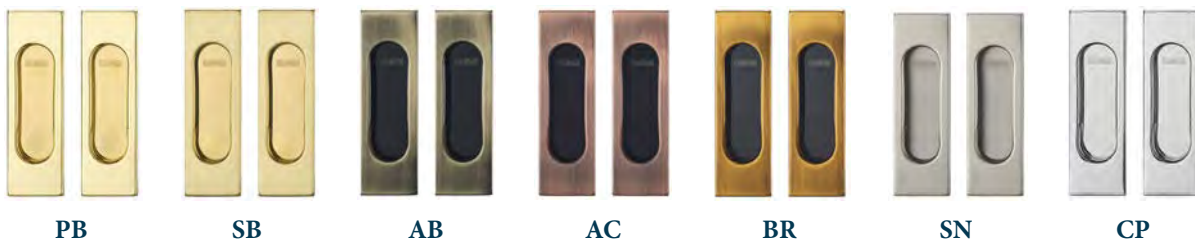

Коп. 30 шт. / Уп. 5 шт.
Ctn. 30 pcs / box 5 pcs.

SS1-A Сантехническая (Sanitary)

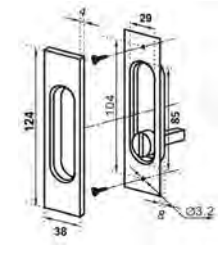

Коп. 30 шт. / Уп. 5 шт.
Ctn. 30 pcs / box 5 pcs.

Замки: почтовые и мебельные

SS1-R

Под замок (For lock body)



PB



SB



AB



AC



BR



SN



CP

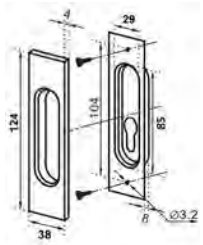

Кор. 30 шт./Уп. 5 шт.
Ctn. 30/bo x 5 pcs.

FL1

Замок мебельный (Furniture lock)



FL1



FL1-S*



Кор. 240 шт. / Уп.12 шт.
Ctn. 240 pcs / bo x 12 pcs.

FL2



FL2



FL2-S*

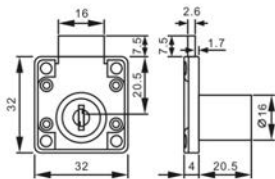

* Модель "S" - ключ не вынимается при открытом положении замка
Model "S" - the key is not able to remove when the lock is open

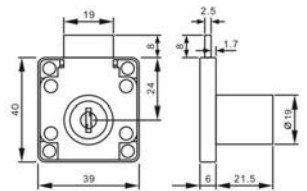

CL1

Замок почтовый (Zip lock)



CL1-S

Замок почтовый (Zip lock)



Кор. 240 шт. / Уп.12 шт.
Ctn. 240 pcs / bo x 12 pcs.

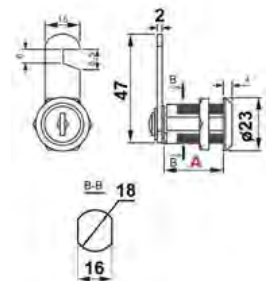

Размер (size) A:		
CL1-16	CL1-16-S	16 мм
CL1-20	CL1-20-S	16 мм
CL1-25	CL1-25-S	16 мм
CL1-30	CL1-30-S	16 мм

* Модель «S» - ключ не вынимается при открытом положении замка
(Model «S» - the key is not able to remove when the lock is open)

В комплекте шайба для установки в деревянные шкафы, тумбочки

Новые почтовые "кодовые" замки - см. в конце каталога (Л.121) !

KR1

Цилиндрический механизм
Крестовый ключ. Материал - латунь, ключи - сталь

Cylinder with cross key
Brass cylinder. 5 steel keys

SP-PL1

ответная планка к замкам CL, FL
(Strike plate to the lock CL)



Кор. 120 шт. / Уп.12 шт.
Ctn. 120 pcs / bo x 12 pcs.

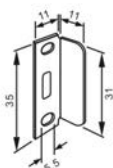
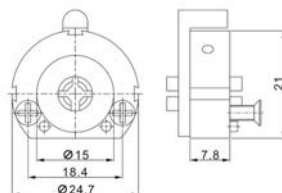

N

Простой ключ-ключ
 Материал цилиндра - латунь. 5 латунных ключей.
 5 пин. Винт в цвет цилиндра.

Duble open cylinder, normal key
 Brass cylinder. 5 brass keys. with 5 pins.
 screw and cylinder in same color.



PB



SB



AB



AC



BR



SN

Симметричные (symmetrical)		
Наименование (Item name)	Цвет (color)	Упаковка/шт. * (ctn/bo x)
N54mm:	SN	48/6
N60mm:	PB-SB-AB-AC-SN	48/6
N70mm:	PB-SB-AB-AC-BR-SN	48/6
N80mm:	PB-SB-SN	48/6
N90mm:	PB-SN	48/6
N100mm:	PB-SB-SN	48/6

Не симметричные (asymmetrical)		
Наименование (Item name)	Цвет (color)	Упаковка/шт. * (ctn/bo x)
N34/28mm:	PB-SN	48/6
N37/31mm:	PB-SN	48/6
N40/30mm:	PB-SN	48/6
N45/35mm:	PB-SN	48/6

*старые поставки - упаковка 72/12



NW

Простой ключ-верт ушка
 Материал цилиндра - латунь. 5 латунных ключей.
 5 пин. Винт в цвет цилиндра.

Single open cylinder, normal key
 Brass cylinder. 5 brass keys. with 5 pins.
 screw and cylinder in same color.



PB



SB



AB



BR



AC



CP



SN

Симметричные (symmetrical)		
Наименование (Item name)	Цвет (color)	Упаковка/шт. * (ctn/bo x)
NW60mm:	PB-SB-AB-AC-CP-SN	48/6
NW70mm:	PB-SB-AB-AC-BR-CP-SN	48/6
NW80mm:	PB-SN	48/6
NW90mm:	PB-SN	48/6
NW100mm:	PB-SB-SN	48/6

Не симметричные (asymmetrical)		
Наименование (Item name)	Цвет (color)	Упаковка/шт. * (ctn/bo x)
NW35/45mm:	PB-SN	48/6
NW37/31mm:	PB-SN	48/6
NW40/30mm:	PB-SN	48/6
NW45/35mm:	PB-SB-SN	48/6

*старые поставки - упаковка 72/12



Цилиндровый механизм C

Cylinder C



C

Перфо ключ-ключ

Материал цилиндра - латунь. 5 латунных ключей. 7 пин. (60 мм-6). Винт в цвет цилиндра. Штифт от высверливания.

Duble open cylinder, computer key

Brass cylinder. 5 brass keys. with 7 pins. screw and cylinder in same color. Anti-drill pin



PB

SB

AB

AC

BR

CP

SN

Симметричные (symmetrical)		
Наименование (Item name)	Цвет (color)	Упаковка/шт. (ctn/bo x)
C60mm:	PB-SB-AB-AC-SN-BR	48/6
C70mm:	PB-SB-AB-AC-BR-SN-CP	48/6
C80mm:	PB-AB-SN	48/6
C90mm:	PB-AB-SN	48/6
C100mm:	PB-AB-SN	48/6
C110mm:	PB-SB-AB-SN	48/6
C120mm:	PB-AB-SN	48/6
C130mm:	PB-AB-SN	48/6
C140mm:	PB-AB-SN	48/6
C150mm:	PB-AB-SN	48/6

Не симметричные (asymmetrical)		
Наименование (Item name)	Цвет (color)	Упаковка/шт. (ctn/bo x)
C37/31mm:	PB-SN	48/6
C40/30mm:	PB-AB-SN	48/6
C45/35mm:	PB-AB-SN	48/6
C50/30mm:	PB-SN	48/6
C50/35mm:	PB-SN	48/6
C50/40mm:	PB-SN	48/6
C55/35mm:	PB-AB-SN	48/6
C55/40mm:	PB-SN	48/6
C55/45mm:	PB-SN	48/6
C60/30mm:	PB-SN	48/6
C60/40mm:	PB-AB-SN	48/6
C53/32:	PB-SN	48/6
C65/35mm:	PB-AB-SN	48/6
C70/40mm:	PB-SN	48/6

C70mm: **ВК (черный) - НОВИНКА, 24 г.**

CA (C60mm DAMX)

С - тип цилиндра - перфо ключ-ключ, А - размер

С - dable open cylinder, computer key, A - size

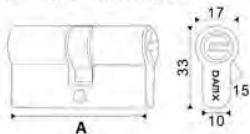

CA/B (C50/30mm DAMX)

С - тип цилиндра - перфо ключ-ключ, А/В - размер

С - dable open cylinder, computer key, A/B - size

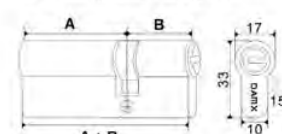

N30/10

Простой ключ

Материал цилиндра и ключей - латунь. 5 пин. 5 ключей. Винт в цвет цилиндра.

Normal key

The material of cylinder and keys brass. 5 brass keys. with 5 pins. Screw and cylinder in same color.



PB



SN

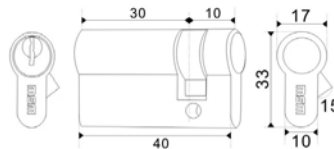

Кор. 72 шт. / Уп.6 шт.
Ctn. 72 / bo x 6 pcs.

C30/10

Перфо ключ

Материал цилиндра - латунь. 5 латунных ключей. 7 пин. (60 мм-6). Винт в цвет цилиндра. Штифт от высверливания.

Computer key

Brass cylinder. 5 brass keys. with 7 pins. screw and cylinder in same color. Anti-drill pin



SN



PB

NW70-20K

цилиндр и 20 ключей



Кор. 48 шт. / Уп.6 шт.
Ctn. 48 / bo x 6 pcs.

CW

Перфо ключ

Материал цилиндра - латунь. 5 латунных ключей. 5 пин. Штифт от высверливания. Винт в цвет цилиндра.

Computer key

The material of cylinder and keys brass. 5 brass keys. with 7 pins. Anti-drill pin. Screw and cylinder in same color.

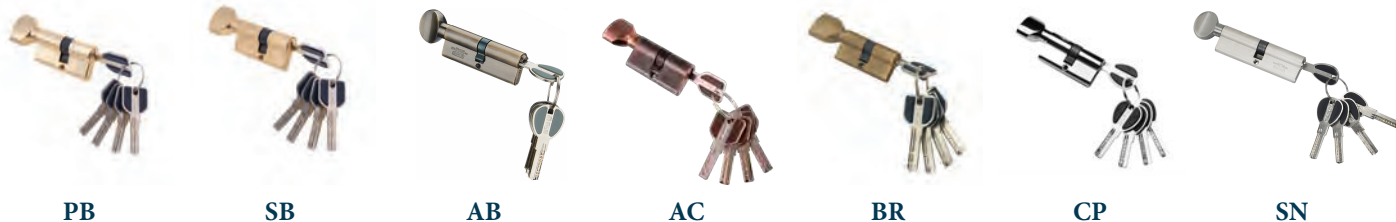

Симметричные (symmetrical)		
Наименование (Item name)	Цвет (color)	Упаковка/шт. (ctn/bo x)
CW60	PB, SB, AB, BR, AC, SN, CP	48/6
CW70	PB, SB, AB, BR, AC, SN, CP	48/6
CW80	PB, AB, SN	48/6
CW90	PB, AB, SN	48/6
CW100	PB, AB, SN	48/6
CW110	PB, AB, SN	48/6
CW120	AB PB,SN	48/6

Не симметричные (asymmetrical)		
Наименование (Item name)	Цвет (color)	Упаковка/шт. (ctn/bo x)
CW30/40mm:	PB-SN	48/6
CW30/50mm:	PB-SN	48/6
CW30/60mm:	PB-SN	48/6
CW35/45mm:	PB-SN	48/6
CW35/55mm:	PB-SN-AB	48/6
CW35/65mm:	PB-SN	48/6
CW37/31mm:	PB-SN	48/6
CW40/30mm:	PB-SN-AB	48/6, 72/6
CW40/50mm:	PB-SN	48/6
CW40/60mm:	PB-SN	48/6
CW45/35mm:	PB-SN-AB	48/6
CW45/55mm:	PB-SN	48/6
CW50/40mm:	PB-SN	48/6
CW50/60mm:	PB-SN	48/6
CW55/35mm:	PB-SN-AB	48/6
CW55/45mm:	PB-SN	48/6
CW60/50mm:	PB-SN	48/6
CW65/35mm:	PB-SN-AB	48/6
CW40/70mm:	PB-SN	48/6
CW60/40mm:	PB-SN-AB	48/6

CW130 - CW140 - CW150 SN - Новинки, уже в наличии



Вид вертушки может отличаться (The turntable model may differ from the drawing)

CW50/30mm: NEW, приход в 24 г.
CW60/30mm:

N70-AK1

Одинаковый ключ
(Identical key). 70 мм

Материал цилиндра и ключей - латунь. Каждый цилиндр с 1 ключом. Все ключи одинаковы.
(The material of cylinder and keys brass. Each package contains 1 cylinder with 1 key. All keys are the same).



SN

N70-MK1

Мастер-ключ
(Master Key). 70 мм

НЕТ Материал цилиндра и ключей - латунь. У каждого цилиндра 3 своих ключа на 12 цилиндров 3 мастер-ключа.
(The material of cylinder and keys brass. Each cylinder has 3 keys. There are 3 master keys for 12 cylinders).



Кор. 46 шт. / Уп.12 шт.
Ctn. 46 / box 12 pcs.

Цилиндровый механизм DAMX Cylinder DAMX



N

Простой ключ
(Normal key)

Простой ключ

Материал вставки цилиндра - латунь.
Корпуса - ЦАМ. Ключ - сталь.
5 пин. 5 ключей. Винт в цвет цилиндра.

Normal key

Cylinder insert is brass. Body is zink
5 steel keys. With 5 pins.
Screw and cylinder in same color.

NA/B (N40/30mm DAMX)

N - простой ключ, A/B - размер
N - cylinder type - normal key, A/B - size

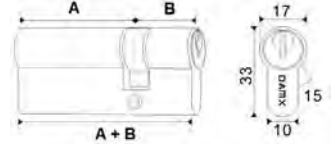

PB



AB



AC



BR



SN

Наименование (Item name)	Цвет (color)	Упаковка/шт. (ctn/bo x)
N60	PB, AB, AC, BR, SN	80/20
N70	PB, AB, AC, BR, SN	80/20
N80	PB, AB, SN	80/20
N90	PB, SN	60/10

Наименование (Item name)	Цвет (color)	Упаковка/шт. (ctn/bo x)
N40/30	PB, SN	60/10
N45/35	PB, SN	80/20
N55/35	PB, SN	60/10

NW

Простой ключ
(Normal key)

Простой ключ

Материал вставки цилиндра - латунь.
Корпуса - ЦАМ. Ключ - сталь.
5 пин. 5 ключей. Винт в цвет цилиндра.

Normal key

Cylinder insert is brass. Body is zink
5 steel keys. With 5 pins.
Screw and cylinder in same color.

NWA (NW60 mm DAMX)

N - тип ключа-простой, W - вертушка, A - размер
N - cylinder type - normal key, W - turntable, A - size

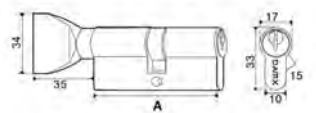

NWA/B (NW35/45mm DAMX)

N - простой ключ, W - вертушка, A - размер со стороны вертушки, B - со стороны ключа
N - normal key, W - turntable, A - size on the turntable side, B - the size of the side of key

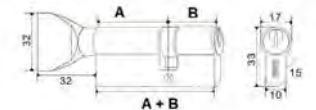

PB



AB



AC



SN



BR

Наименование (Item name)	Цвет (color)
NW60	PB, AB, AC, BR, SN
NW70	PB, AB, AC, BR, SN
NW80	PB, AB, SN

Наименование (Item name)	Цвет (color)
NW35/45	PB, SN
NW35/55	PB, SN
NW45/35	PB, SN

Кор. 80 шт./Уп.20 шт.
ctn. 80 pcs./ bo x 20 pcs.

W70

Сантехнический
(Sanitary)

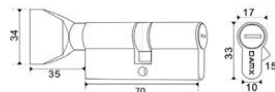

PB



SB



AB



AC



BR



SN

N70-20K SN

1 цилиндр и 20 ключей



Кор. 60 шт. / Уп.10 шт.
Ctn. 60 pcs / bo x 10 pcs.



NW0-20K SN

1 цилиндр и 20 ключей



C

Перфо ключ

Материал вставки цилиндра - латунь.
Корпуса - ЦАМ. Ключ - сталь.
5 пин. 5 ключей. Винт в цвет цилиндра.

Computer key

Cylinder insert is brass. Body is zink
5 steel keys. With 5 pins.
Screw and cylinder in same color.



PB



AB



AC



BR



SN



Кор. 80 шт./Уп.20 шт.
ctn. 80 pcs./ box 20 pcs.

Симметричные (symmetrical)	
Наименование (Item name)	Цвет (color)
C60	PB, SB, AB, AC, BR, SN
C70	PB, AB, AC, BR, SN
C80	PB, AB, SN
C90	PB, AB, SN
C100	PB, AB, SN
C110	SN AB, PB NEW

Не симметричные (asymmetrical)	
Наименование (Item name)	Цвет (color)
C40/30	PB, SN AB-ожидаем
C45/35	PB, SN
C50/30	PB, SN
C50/40	PB, SN
C55/35	PB, AB, SN
C65/35	PB, SN



CW

Перфо ключ

Материал вставки цилиндра - латунь.
Корпуса - ЦАМ. Ключ - сталь.
5 пин. 5 ключей. Винт в цвет цилиндра.

Computer key

Cylinder insert is brass. Body is zink
5 steel keys. With 5 pins.
Screw and cylinder in same color.



PB



AB



AC



BR



SN



BK



CP



Кор. 80 шт. / Уп.20 шт.
Ctn. 80 pcs. / box 20 pcs.

Симметричные (symmetrical)		
Наименование (Item name)	Цвет (color)	Упаковка/шт. (ctn/bo x)
CW60	PB, AB, AC, BR, SN BK-CP	
CW70	PB, AB, AC, BR, SN BK-CP	
CW80	PB, AB, SN	80/20
CW90	PB, AB, SN	60/10
CW100	PB, AB, SN	60/10
CW110	SN AB, PB NEW	60/10

Не симметричные (asymmetrical)	
Наименование (Item name)	Цвет (color)
CW35/45	PB, SN
CW35/55	PB, SN
CW40/30	PB, SN
CW40/50	PB, SN
CW45/35	PB, SN
CW50/60	SN

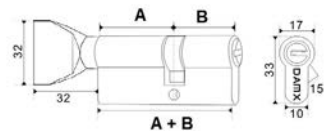
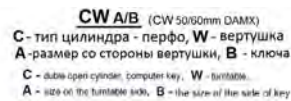
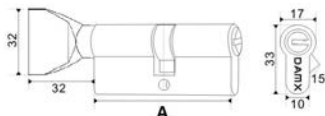
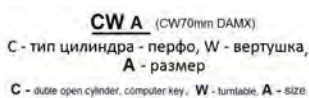

Замки навесные



TS1

Корпус - сталь
Дужка - закаленная сталь
Запирание без ключа
Резиновые уплотнители на дужке
Тип ключа - простой (английский)
Кол-во ключей - 3 шт.

Steel lock body
Hardened steel shackle
Keyless locking
Rubber seals on the shackle
Normal key (English type key)
Number of keys 3

TS1

Блистер (Blister)

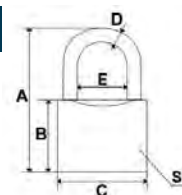

Наименование (Item name)	Размер в мм (size)						Упаковка картон, шт. (Box packaging)	Упаковка блистер (Blister packaging)
	A	B	C	D	E	S		
TS1-20	35	20	21	3	10	11	12/360	12/120
TS1-25	43	25	25	4	12	12	12/120	12/120
TS1-30	53	30	32	5	15	15	12/180	12/60
TS1-40	64	35	38	7	20	17	12/120	12/60
TS1-50	80	43	50	9	26	22	6/60	6/36
TS1-60	100	51	62	11	32	25	6/36	6/24
TS1-75	113	58	75	12	38	27	6/24	6/24

TS1L

Корпус - сталь
Дужка - закаленная сталь
Запирание без ключа
Резиновые уплотнители на дужке
Тип ключа - простой (английский)
Кол-во ключей - 3 шт.

Steel lock body
Hardened steel shackle
Keyless locking
Rubber seals on the shackle
Normal key (English type key)
Number of keys 3

TS1L

Блистер (Blister)

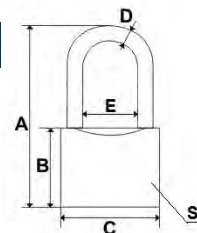

Наименование (Item name)	Размер в мм (size)						Упаковка картон, шт. (Box packaging)	Упаковка блистер (Blister packaging)
	A	B	C	D	E	S		
TS1-L-30	86	30	32	5	15	15	12/60	12/60
TS1-L-40	106	34	38	6	20	17	6/60	6/60
TS1-L-50	125	43	50	9	26	22	6/36	6/36
TS1-L-60	145	51	63	11	32	25	6/24	6/24

TS2

Корпус - сталь
Дужка - закаленная сталь
Тип ключа - простой (английский)
Кол-во ключей - 3 шт.

Steel lock body
Hardened steel shackle
Normal key (English type key)
Number of keys 3

TS2

Блистер (Blister)

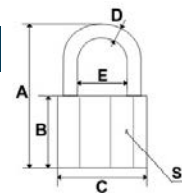

Наименование (Item name)	Размер в мм (size)						Упаковка картон, шт. (Box packaging)	Упаковка блистер (Blister packaging)
	A	B	C	D	E	S		
TS2-60	94	47	63	10	33	22	6/36	6/24
TS2-70	107	55	70	11	40	24	6/36	6/24
TS2-80	114	58	80	12	44	27	6/36	6/24

TS3

Корпус - сталь
Дужка - закаленная сталь
В открытом положении ключ не вынимается
Резиновые уплотнители на дужке
Тип ключа - дисковый
Кол-во ключей - 4 шт.

Steel lock body
Hardened steel shackle
The key cannot be removed in the open position
Rubber seals on the shackle
Disk type key
Number of keys 4

TS3

Блистер (Blister)

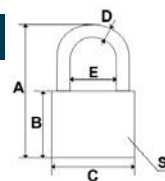

Наименование (Item name)	Размер в мм (size)						Упаковка картон, шт. (Box packaging)	Упаковка блистер (Blister packaging)
	A	B	C	D	E	S		
TS3-40	63	32	40	7	20	20	6/60	6/60
TS3-50	82	38	50	10	23	20	6/48	6/48
TS3-60	92	42	60	11	27	20	6/36	6/24
TS3-70	96	45	70	11	37	20	6/36	6/24



TS3L

Корпус - сталь
Дужка - закаленная сталь
В открытом положении ключ не вынимается
Резиновые уплотнители на дужке
Тип ключа - дисковый
Кол-во ключей - 4 шт.

Steel lock body
Hardened steel shackle
The key cannot be removed in the open position
Rubber seals on the shackle
Disk type key
Number of keys 4

TS3L

Блистер (Blister)

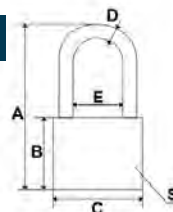

Наименование (Item name)	Размер в мм (size)						Упаковка картон, шт. (Box packaging)	Упаковка блистер (Blister packaging)
	A	B	C	D	E	S		
TS3L-40	93	32	40	7	20	20	6/60	6/48
TS3L-50	114	38	50	10	23	20	6/48	6/34
TS3L-60	127	42	60	11	27	20	6/36	6/24
TS3L-70	139	45	70	11	37	20	6/36	6/24



TS4

Блистер (Blister)

Корпус - сталь
Дужка - закаленная сталь
Запирание без ключа
Тип ключа - перфорированный
Кол-во ключей - 4 шт.

Steel lock body
Hardened steel shackle
Keyless locking
Computer Key
Number of keys 4

TS4L

Блистер (Blister)

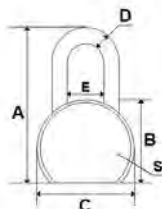

Наименование (Item name)	Размер в мм (size)						Упаковка блистер (Blister packaging)
	A	B	C	D	E	S	
TS4L	106	55	65	10,5	24	28	6/24

Наименование (Item name)	Размер в мм (size)						Упаковка блистер (Blister packaging)
	A	B	C	D	E	S	
TS4L	125	55	65	10,5	24	28	6/24

Замки навесные Padlock



ТВ1

Блистер
(Blister)

Корпус - латунь
Дужка - закаленная сталь
Запирание без ключа
Резиновые уплотнители на дужке
Ключ 20-40 мм - простой
50-70 - перфорированный
Кол-во ключей - 3 шт.

Brass lock body
Hardened steel shackle
Keyless locking
Rubber seals on the shackle
20-40 mm sizes with normal Keys
50-70 mm sizes with computer keys
Number of keys 3



Наименование (Item name)	Размер в мм (size)						Упаковка блистер (Blister packaging)
	A	B	C	D	E	S	
ТВ1-20	35	20	20	3	10	9	12/120
ТВ1-25	44	25	25	4	13	11	12/120
ТВ1-30	50	30	30	5	15	13	12/60
ТВ1-40	64	35	40	7	23	14	12/60
ТВ1-50	80	40	50	8	26	16	6/36
ТВ1-60	90	45	60	10	33	20	6/24
ТВ1-70	108	52	70	11	40	21	6/24

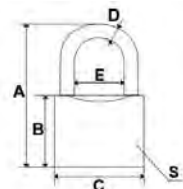

ТВ1-L

Блистер
(Blister)

Корпус - латунь
Дужка - закаленная сталь
Запирание без ключа
Резиновые уплотнители на дужке
Ключ 20-40 мм - простой
50-70 - перфорированный
Кол-во ключей - 3 шт.

Brass lock body
Hardened steel shackle
Keyless locking
Rubber seals on the shackle
20-40 mm sizes with normal Keys
50-70 mm sizes with computer keys
Number of keys 3



Наименование (Item name)	Размер в мм (size)						Упаковка блистер (Blister packaging)
	A	B	C	D	E	S	
ТВ1-L-25	70	25	25	4	13	11	12/120
ТВ1-L-30	80	30	30	5	15	13	12/60
ТВ1-L-40	105	35	40	6,5	23	14	12/60
ТВ1-L-50	120	40	50	8	26	16	6/36
ТВ1-L-60	130	45	60	10	33	20	6/24
ТВ1-L-70	145	52	70	11	40	21	6/24
ТВ1-70	108	52	70	11	40	21	6/24

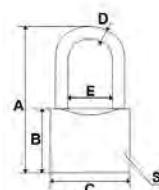

VS1

Корпус - сталь, с защитой дужки
Дужка - закаленная сталь
Запирание без ключа
Тип ключа - перфорированный
Кол-во ключей - 3 шт.

Steel Lock body, with shackle protection
Hardened steel shackle
Keyless locking
Computer Key
Number of keys 3

VS1

Блистер
(Blister)



Наименование (Item name)	Размер в мм (size)						Упаковка картон, шт. (Box packaging)	Упаковка блистер (Blister packaging)
	A	B	C	D	E	S		
VS1-40	39	34	38	7	18	20	6/60	6/60
VS1-50	78	42	50	9	22	22	6/60	6/60
VS1-60	95	48	62	10	30	24	6/36	6/36
VS1-70	108	56	75	11	36	24	6/24	6/24

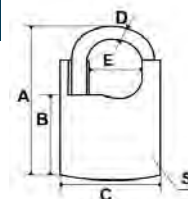

VS3

Корпус - сталь, с защитой дужки
Дужка - закаленная сталь
В открытом положении ключ не вынимается
Тип ключа - дисковый
Кол-во ключей - 4 шт.

Steel Lock body, with shackle protection
Hardened steel shackle
The key cannot be removed in the open position
Disk type key
Number of keys 4

VS3

Блистер (Blister)

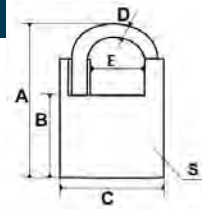

Наименование (Item name)	Размер в мм (size)						Упаковка картон, шт. (Box packaging)	Упаковка блистер (Blister packaging)
	A	B	C	D	E	S		
VS3-40	39	34	38	7	19	20	6/60	6/48
VS3-50	78	42	50	9	23	20	6/60	6/48
VS3-60	95	48	62	10	28	20	6/36	6/24
VS3-70	108	56	75	11	36	20	6/36	6/24



WB1

Блистер (Blister)

Корпус - латунь, с защитой дужки
Дужка - закаленная сталь
В открытом положении ключ не вынимается
Ключ 50-60 мм - простой
70-90 - перфорированный
Кол-во ключей - 3 шт.

Brass Lock body, with shackle protection
Hardened steel shackle
The key cannot be removed in the open position
50-60 mm sizes with normal Keys
70-90 mm sizes with computer keys
Number of keys 3

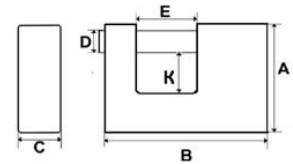

Наименование (Item name)	Размер в мм (size)						Упаковка блистер (Blister packaging)
	A	B	C	D	E	S	
WB1-50	40	50	15	10	12	14	6/72
WB1-60	45	60	15	10	20	17	6/72
WB1-70	50	70	19	12	24	18	6/36
WB1-90	60	90	19	12	36	22	6/36

WS1

Корпус - сталь, с защитой дужки
Дужка - закаленная сталь
В открытом положении ключ не вынимается
Тип ключа - перфорированный
Кол-во ключей - 3 шт.

Steel Lock body, with shackle protection
Hardened steel shackle
The key cannot be removed in the open position
Computer Key
Number of keys 3

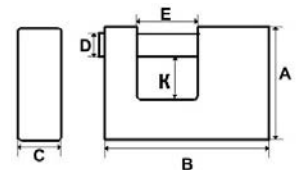

Наименование (Item name)	Размер в мм (size)						Упаковка блистер (Blister packaging)
	A	B	C	D	E	S	
WS1-60	45	17	60	10	15	20	6/36
WS1-70	55	20	70	12	23	20	6/36
WS1-80	55	20	80	12	29	20	6/24
WS1-90	55	20	90	12	36	20	6/24

Замки навесные Padlock



WS2

Корпус: Сталь в чехле из закаленной стали, Защита дужки от силовых методов вскрытия
Дужка: закаленная сталь
В открытом положении ключ не вынимается
Тип ключа: перфорированный
Кол-во ключей: 3 шт.

Steel Lock body in a hardened steel case, with shackle protection
Hardened steel shackle
The key cannot be removed in the open position
Computer Key
Number of keys 3

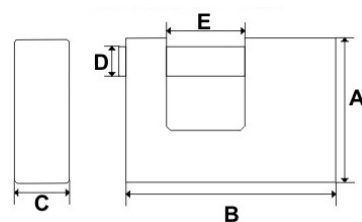

Наименование (Item name)	Размер в мм (size)						Упаковка блистер (Blister packaging)
	A	B	C	D	E	S	
WS2-70	61	22	75	12	23	27	6/24
WS2-80	61	23	85	12	29	27	6/24
WS2-90	70	25	94	14	36	27	6/24

WS3-90

Корпус: чугун, с защитой дужки
Дужка: закаленная сталь
Тип ключа - дисковый
В открытом положении ключ не вынимается
Количество ключей - 3 шт.

Steel Lock body, with shackle protection
Hardened steel shackle
Disk type key
The key cannot be removed in the open position
Number of keys 3



Вес - 1,130 гр



Кор. 8 шт.
ctn. 8 pcs.

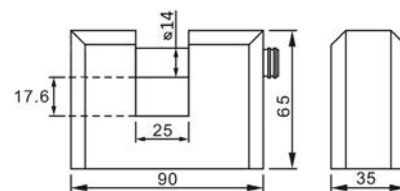

TP1

Корпус: наборные стальные пластины в пластиковом корпусе
Запирание без ключа
Дужка: закаленная сталь, защита из резины.
Количество ключей - 3 шт.

Stacked steel plates body in a plastic cover
The key cannot be removed in the open position
Hardened steel shackle
Number of keys 3

TP1-L

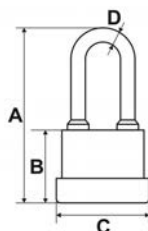

Наименование (Item name)	Размер в мм (size)				Упаковка блистер (Blister packaging)
	A	S	C	D	
TP1-30	50	30	39	6	6/120
TP1-40	67	40	49	7.5	6/72
TP1-50	77.5	44	59	10.5	6/48
TP1-65	97.5	51	74	13	6/24

Наименование (Item name)	Размер в мм (size)				Упаковка блистер (Blister packaging)
	A	S	C	D	
TP1-L30	72	30	39	6	6/120
TP1-L40	88.5	40	49	7.5	6/72
TP1-L50	111.5	44	59	10.5	6/48
TP1-L65	146	51	74	13	6/24

TE1

Корпус: наборные стальные пластины
в пластиковом корпусе
Запирание без ключа
Дужка: закаленная сталь, защита из
резины.
Количество ключей - 3 шт.

Stacked steel plates body
in a plastic cover
Keyless locking
Hardened steel shackle
Number of keys 3

TE1- L



РАЗМЕРЫ TE1-L

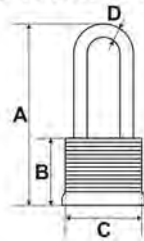

Наименование (Item name)	Размер в мм (size)				Количество, шт.	
	A	S	C	D	Коробка	Упаковка
TE1-30	48.9	26.4	30	5	120	6
TE1-40	63.1	33	40	6.1	60	6
TE1-50	73.8	37.5	50	8.8	48	6
TE1-65	94	45	65	11	24	6

Наименование (Item name)	Размер в мм (size)				Количество, шт.	
	A	S	C	D	Коробка	Упаковка
TE1-L30	70.9	26.4	30	5	120	6
TE1-L40	92.1	33	40	6.1	60	6
TE1-L50	107.3	37.5	50	8.8	48	6
TE1-L65	144	45	65	11	24	6

ТА1-70 БЛИСТЕР

Корпус: алюминиевый сплав
Тип ключа - дисковый
Дужка: закаленная сталь
В открытом положении ключ не
вынимается
Количество ключей - 3 шт.

Steel lock body
Disk type key
Hardened steel shackle
The key cannot be removed
in the open position
Number of keys 3

ТА2-80 БЛИСТЕР

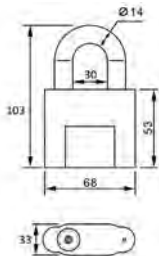

Кор. 24 шт. / Уп.6 шт.
ctn. 24 pcs. / box 6 pcs.

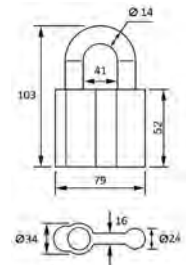

ТА3-60

Корпус: алюминиевый сплав
Тип ключа - дисковый
Дужка: закаленная сталь
В открытом положении ключ не
вынимается
Количество ключей - 3 шт.

Steel lock body
Disk type key
Hardened steel shackle
The key cannot be removed
in the open position
Number of keys 3

ТА3-L60

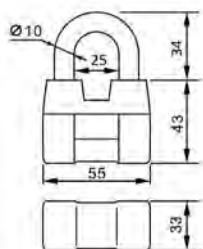

Кор. 24 шт. / Уп.6 шт.
ctn. 24 pcs. / box 6 pcs.

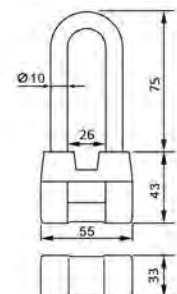

Замки навесные Padlock



RS1-60 БЛИСТЕР

Корпус: Сталь, с защитой дужки от силовых методов вскрытия
Дужка: закаленная сталь
В открытом положении ключ не вынимается
Тип ключа: дисковый
Кол-во ключей: 4 шт.

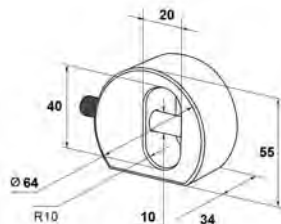

Lock body - cast iron, with protection of the shackle from breaking
Hardened steel shackle
The key cannot be removed in the open position
Disk type key
Number of keys 3



Кор. 24 шт. / Уп.6 шт.
ctn. 24 pcs. / box 6 pcs.

RS2-70 БЛИСТЕР

Корпус: Сталь, с защитой дужки от силовых методов вскрытия
Дужка: закаленная сталь
В открытом положении ключ не вынимается
Тип ключа: английский, латунь
Кол-во ключей: 3 шт.

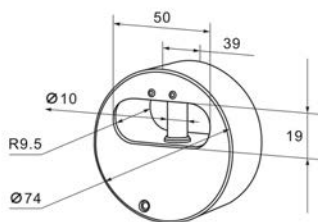

Lock body - cast iron, with protection of the shackle from breaking
Hardened steel shackle
The key cannot be removed in the open position
English type key, steel
Number of keys 3



Кор. 24 шт. / Уп.6 шт.
ctn. 24 pcs. / box 6 pcs.

PR-RS БЛИСТЕР

Сталь, защита замков RS1-60 и RS2-70 от силовых методов вскрытия
Рекомендуемый вариант установки на стальные двери - сварка.

Material is steel, protection of locks RS1-60 and RS2-70 against break in, against break in, recommended installation option by welding.

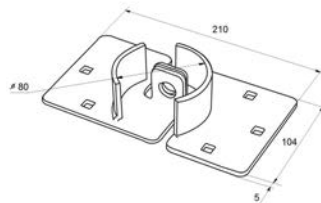

Кор. 12 шт. / Уп.6 шт.
ctn. 12 pcs. / box 6 pcs.

KS1-90

Корпус: чугун
Тип ключа - дисковый, Дужка: закаленная сталь
В открытом положении ключ не вынимается
Количество ключей - 3 шт.

Lock body - cast iron
Disk type key. Hardened steel shackle
The key cannot be removed in the open position
Number of keys 3.



Вес: 1,9 кг
Weight: 1,9 kg

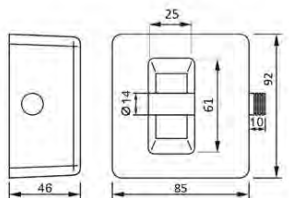

KS1-85



Кор. 8 шт.
ctn. 8 pcs.

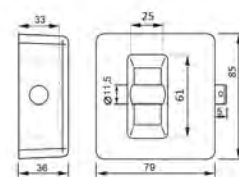

Вес: 1,2 кг
Weight: 1,2 kg

TS5-80



Корпус: чугун
 Тип ключа - дисковый
 Дужка: закаленная сталь
 В открытом положении ключ не вынимается
 Количество ключей - 3 шт.
 Вес: 1 кг
 Lock body - cast iron
 Disk type key
 Hardened steel shackle
 The key cannot be removed in the open position
 Number of keys 3
 Weight: 1 kg

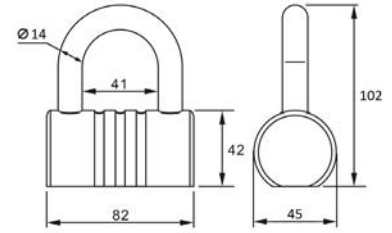

Кор. 8 шт.
 ctn. 8 pcs.

TS1-AK-50

Замки под один ключ
 Размер - 50 мм
 Size - 50 mm

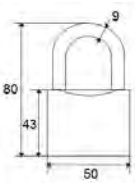

Одинаковый ключ

У замка 1 ключ.
 Все ключи в партии
 одинаковые (открывают все замки).
 Замки под один ключ

The lock has 1 key.
 Body steel lock
 With identical key
 Identical key

Кор. 60 шт. / Уп.6 шт. Кор. 120 шт. / Уп.12 шт.
 Ctn. 60 pcs. / box 6 pcs. Ctn. 120 pcs. / box 12 pcs.

TS1-AK-30

Замки под один ключ
 Размер - 30 мм
 Size - 30 mm



TB1-AK-30

Размер - 30 мм
 Size - 30 mm



У замка 1 ключ.
 Все ключи в партии
 одинаковые (открывают все
 замки). Замки под один ключ.

The lock has 1 key.
 Brass lock body
 With identical key
 Identical key

Кор. 120 шт. / Уп.6 шт.
 Ctn. 120 pcs. / box 6 pcs.

TB1-AK-50

Размер - 50 мм
 Size - 50 mm



Кор. 36 шт. / Уп.6 шт.
 Ctn. 36 pcs. / box 6 pcs.

FH1

Замки навесные кодовые
 У всех замков можно изменить код
 Code padlock
 You can change the code for all luggage locks

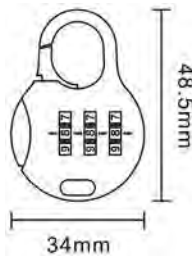

FH2

Замки навесные кодовые
 У всех замков можно изменить код
 Code padlock
 You can change the code for all
 luggage locks

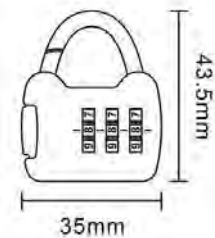

FH3

У всех замков можно изменить код
 You can change the code for all luggage locks

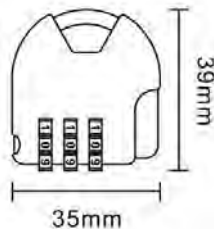

FH4



Кор. 360 шт. / Уп.12 шт.
 ctn. 360 pcs. / box 12 pcs.

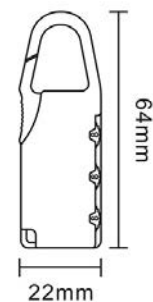

Замки навесные кодовые

Code padlock



У всех замков можно изменить код
You can change the code for all luggage locks

FH5

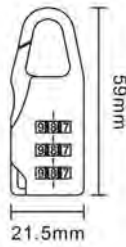

TH1

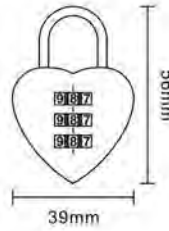

TH2

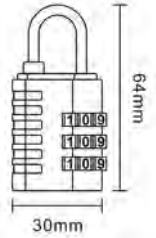

TH3



TH4

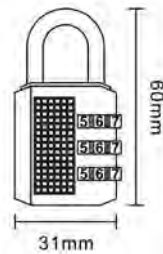

TH5

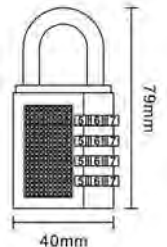

Кор. 360 шт. / Уп.12 шт.
ctn. 360 pcs. / box 12 pcs.

TH6

Кор. 72 шт. / Уп.12 шт.
ctn. 72 pcs. / box 12 pcs.

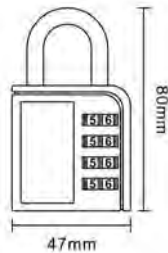

THK1

Кор. 360 шт. / Уп.12 шт.
ctn. 360 pcs. / box 12 pcs.

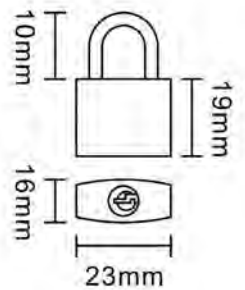

THK2

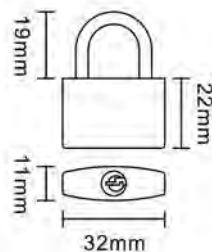

Кор. 240 шт. / Уп.12 шт.
Ctn. 240 pcs. / box 12 pcs.

THK3

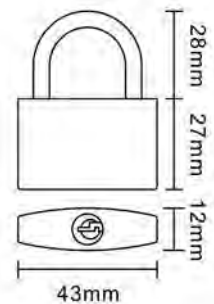

Кор. 120 шт. / Уп. 12 шт.
Ctn. 120 pcs / box 12 pcs

TSAK1

Может быть вскрыт, при проверке на таможене, и закрыт, а не сломан как другие. Индикатор покажет вскрылся ли замок.
It can be opened, when checked at customs, and closed, and not broken like others. The indicator will show whether the lock was opened.



У всех замков можно изменить код
You can change the code for all luggage locks

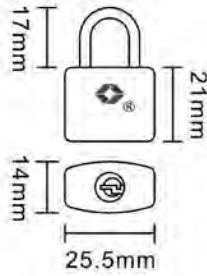

Кор. 360 шт. / Уп.12 шт.
Ctn. 360 pcs. / box 12 pcs.

TSA1

Кор. 120 шт. / Уп. 12 шт.
Ctn. 120 pcs / box 12 pcs

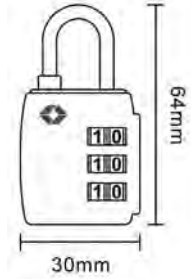

TSA2

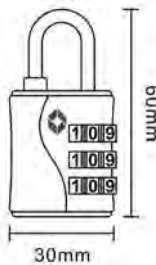

TSA3

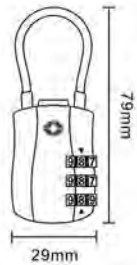

Кор. 120 шт. / Уп. 12 шт.
Ctn. 120 pcs / box 12 pcs

Может быть вскрыт, при проверке на таможене, и закрыт, а не сломан как другие. Индикатор покажет вскрылся ли замок.
It can be opened, when checked at customs, and closed, and not broken like others. The indicator will show whether the lock was opened.

VH1

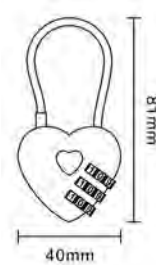

Кор. 360 шт. / Уп.12 шт.
Ctn. 360 pcs. / box 12 pcs.

VH2

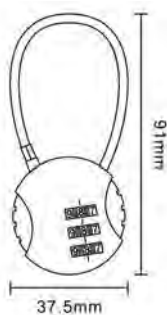

Кор. 360 шт. / Уп.12 шт.
Ctn. 360 pcs. / box 12 pcs.



VH3

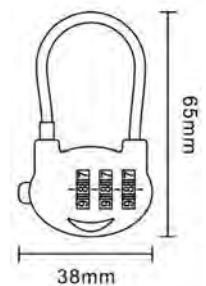

KB1

Замок кодовый

Корпус: Латунь
Дужка: закаленная сталь
с возможностью смены кода

Brass Lock body
Hardened steel shackle
Code type lock, with the possibility
of changing the opening code



Наименование (Item name)	Размер в мм (size)				Упаковка/шт. (ctn/box)
	A	S	C	D	
KB1-20	60	35	22	3	10/100
KB1-28	80	50	28	5	10/100
KB1-38	85	50	40	8	6/60

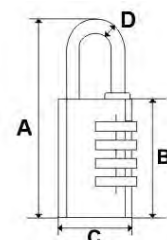

Петли стальные (универсальные)

Universal door hinges, steel



3I 75 мм

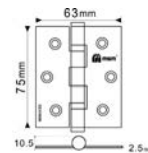

Кор. 100 шт. /
Упак. 20 шт.
Ctn. 100 pcs. /
box x 20 pcs.

4I 100 мм

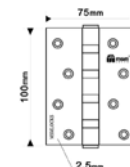

Кор. 100 шт. /
Упак. 20 шт.
Ctn. 100 pcs. /
box x 20 pcs.

4/3 I

аналог 4I. Толщина - 3 мм
(-analog of 4I. Differs in thickness - 3 mm)

Цвета (Color): PB



SN

4IK 100 мм

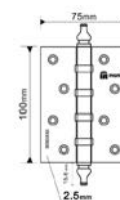
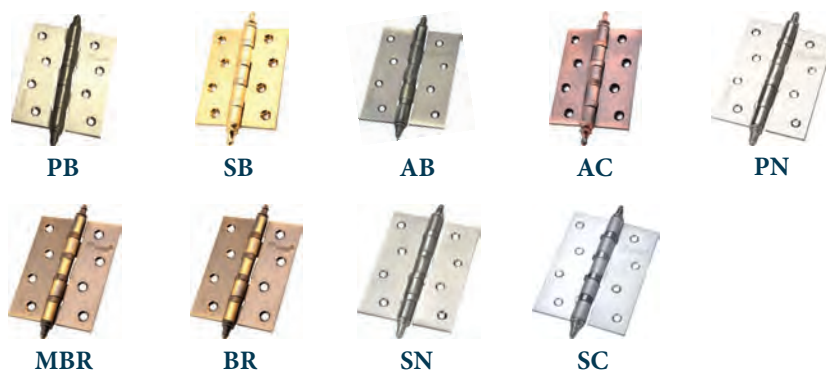

Кор. 100 шт. / Упак. 20 шт.
Ctn. 100 pcs. / box x 20 pcs.

4IN

100 мм

БЕЗ ВРЕЗКИ
Overhead hinges (not mortise)

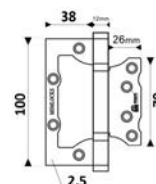

Кор. 100 шт. / Упак. 20 шт.
Ctn. 100 pcs. / box x 20 pcs.

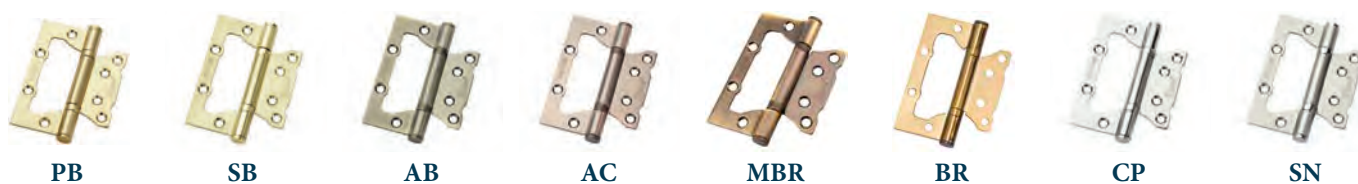

5I 120 MM



PB



SB



AB



AC

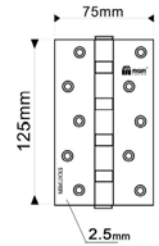

MBR



BR



CP



SN

5IK 125 MM



AC



PB



SB



AB

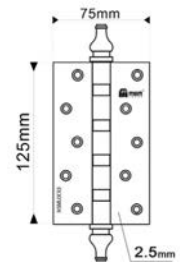

BR



MBR



SC



SN



Кор. 100 шт. / Упак. 20 шт.
Ctn. 100 pcs. / box 20 pcs.

5IN 125 MM

БЕЗ ВРЕЗКИ
Overhead hinges
(not mortise)



PB



AB



SN

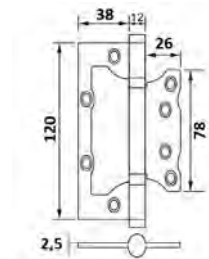

4IW 100 MM

Полунакладные
(Semi-Overhead hinges)



PB



AB



SN

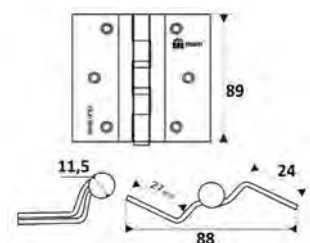

Петли стальные (разъемные) Removable door hinge, steel



91/87-I



SN

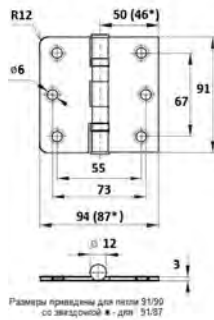

Кор. 100 шт. / Упак. 20 шт.
Ctn. 100 pcs. / box 20 pcs.

91/90-I



PB - спеццена

L3I R3I

75 mm

L3I - левая (Left)
R3I - правая (Right)



PB



SB



AB

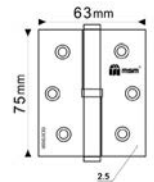

AC



SN



Кор. 100 шт. / Упак. 20 шт.
Ctn. 100 pcs. / box 20 pcs.

L3IK R3IK

75 mm

L3IK - левая (Left)
R3IK - правая (Right)



PB



SB



AB

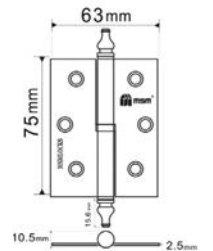

AC



SN - в остатке левые



Кор. 100 шт. / Упак. 20 шт.
Ctn. 100 pcs. / box 20 pcs.

L4I R4I

100 mm

L4I - левая (Left)
R4I - правая (Right)



PB



AB



AC



CP (PN)

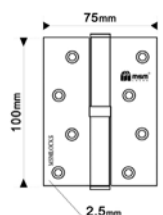

MBR



BR



SN



SG



SC



Кор. 100 шт. / Упак. 20 шт.
Ctn. 100 pcs. / box 20 pcs.

L4IK R4IK

L4IK - левая (Left)
R4IK - правая (Right)

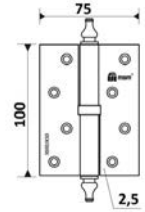

MBR



PN



SN



SC - скидка >55%



Кор. 100 шт. / Упак. 20 шт.
Ctn. 100 pcs. / box 20 pcs.

L4I R4I

упаковка блистер
Blister packaging

L4I - левая (Left)
R4I - правая (Right)



SB



AC



Кор. 100 шт. / Упак. 20 шт.
Ctn. 100 pcs. / box 20 pcs.

L4IK R4IK

упаковка блистер
Blister packaging

L4IK - левая (Left)
R4IK - правая (Right)



PB, SB, AB, AC
L4IK SC - остаток

L110I R110I

L110I - левая (Left)
R110I - правая (Right)

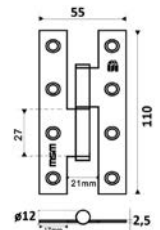
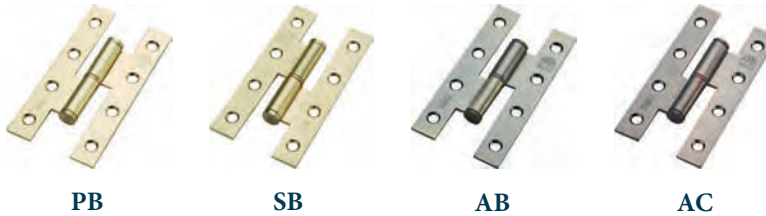

MBR



SN



SC



Кор. 100 шт. / Упак. 20 шт.
Ctn. 100 pcs. / box 20 pcs.

L110IK R110IK

L110IK - левая (Left)
R110IK - правая (Right)

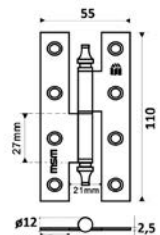

SN



SC



Кор. 100 шт. / Упак. 20 шт.
Ctn. 100 pcs. / box 20 pcs.

Петли стальные (разъемные) Removable door hinge, steel



L5I
R5I

L5I - левая (Left)
R5I - правая (Right)

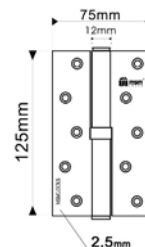
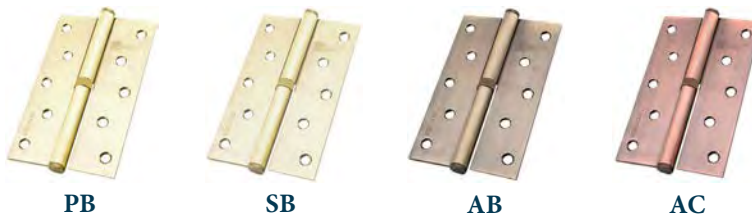

Кор. 100 шт. / Упак. 20 шт.
Ctn. 100 pcs. / box 20 pcs.

L5IK
R5IK

L5IK - левая (Left)
R5IK - правая (Right)

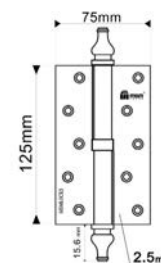
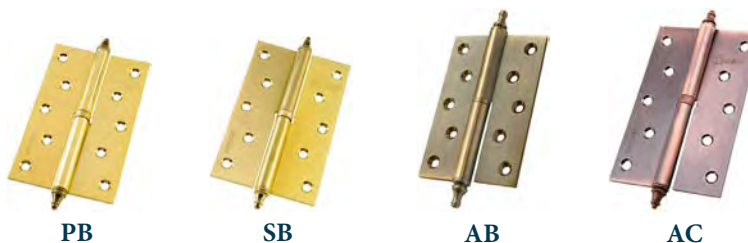

Кор. 100 шт. / Упак. 20 шт.
Ctn. 100 pcs. / box 20 pcs.



Петли латунированные Brass door hinge

4Z

Универсальные (universal)

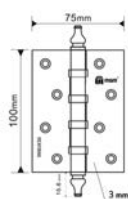

Кор. 100 шт. / Упак. 20 шт.
Ctn. 100 pcs. / box 20 pcs.

4ZK

Универсальные (universal)



I-20/16



PN

WH

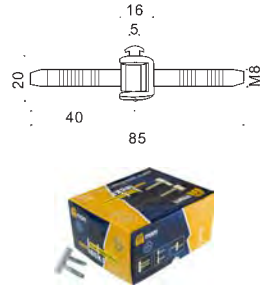

Кор. 400 шт. / Мал.100 шт.
Ctn. 400 pcs. / box 100 pcs.

I-140/20

Петля приварная каплевидная, с подшипником (Weld-on hinge with bearing)

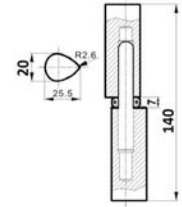

Кор. 40 шт. / Упаk.10 шт.
Ctn. 40 pcs. / box 10 pcs.

I-37/11



PB



PN



WH



Кор. 600 шт. / Упаk.150 шт.
Ctn. 600 pcs. / box 150 pcs.

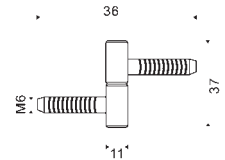

I-42/13



PB



MBR



PN



WH

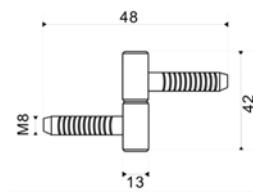

Кор. 400 шт. / Упаk.100 шт.
Ctn. 400 pcs. / box 100 pcs.

I-52/16



PB



MBR



PN



WH

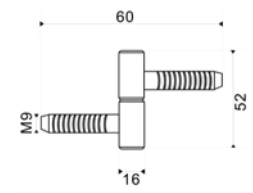

Кор. 200 шт. / Упаk.50 шт.
Ctn. 200 pcs. / box 50 pcs.

Дверные доводчики, морозостойкие

Door closer (frost-resistant, anti fire)

D50

Вес двери до 50 кг
(Door weight up to 50 kg)

Подходят для установки на противопожарные двери
(Suitable for installation on fireproof doors)



WH



SL



112

BR



GP



Дверные доводчики, морозостойкие

Door closer (frost-resistant, anti fire)



D75

Вес двери до 75 кг
(Door weight up to 75 kg)

Подходят для установки на противопожарные двери
(Suitable for installation on fireproof doors)



SL



WH



BR



GP



BK



D100

Вес двери до 100 кг
(Door weight up to 100 kg)



BR



SL



WH



GP



D140

Вес двери до 140 кг
(Door weight up to 140 kg)



GP



SL



WH



BR



D180

Вес двери до 180 кг
(Door weight up to 180 kg)



SL



WH



GP



BR



Кор. 10 шт.
Ctn. 10 pcs.

DM80

Вес двери до 80 кг
(Door weight up to 80 kg)



SL



BR



GP



BK



WH

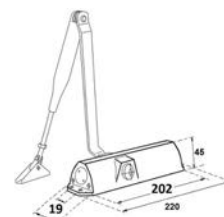

DM 120 Вес двери до 120 кг
(Door weight up to 120 kg)

Подходят для установки на противопожарные двери
(Suitable for installation on fireproof doors)



WH



SL



BR



GP



BK

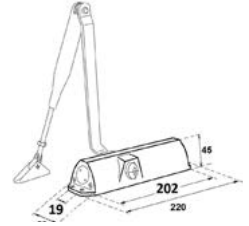

Кор. 10 шт.
Ctn. 10 pcs.

DD 75 Вес двери до 75 кг
(Door weight up to 75 kg)

Со скользящей тягой
(With sliding traction)

DD 100 Вес двери до 100 кг
(door weight up to 100 kg)



WH



SL



BR - Новинка

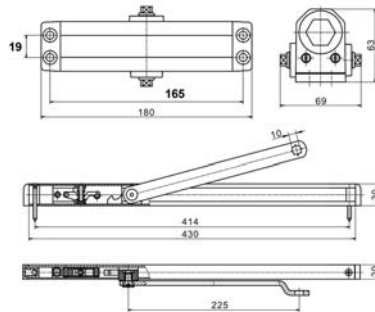

Кор. 8 шт.
Ctn. 8 pcs.



SL



WH

BR - Новинка

DV 100 Вес двери до 100 кг
(Door weight up to 100 kg)

Врезной
(Mortise door closer)

DV 140 Вес двери до 140 кг
(Door weight up to 140 kg)

Новинка



SL

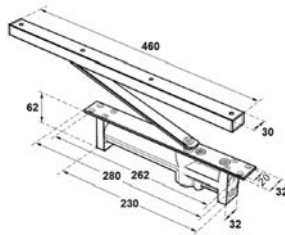

Кор. 10 шт.
Ctn. 10 pcs.



SL

DT 85 Вес двери до 85 кг
(Door weight up to 85 kg)

Пружинный
(Spring-loaded door closer)

DD 140

Вес двери до 100 кг
(door weight up to 100 kg)



BR



WH



SL



GP



CP

Кор. 36 шт. / Упак. 6 шт.
Ctn. 36 pcs. / box 6 pcs.



SL

Новинка

G 3



PB/SB



MAB



MBR



BSN/GR



SN/CP

G 6



PB/SB



MAB



MBR



SN/CP



Коп. 24 шт.
Ctn. 24 pcs.

G 9



PB/SB



MAB



MBR



SN/CP



Коп. 24 шт.
Ctn. 24 pcs.

G 10



PB/SB



MAB



MBR



SN/CP



Коп. 24 шт.
Ctn. 24 pcs.

G 11



PB/SB



MAB



BSN/GR



MBR



SN/CP

G 5

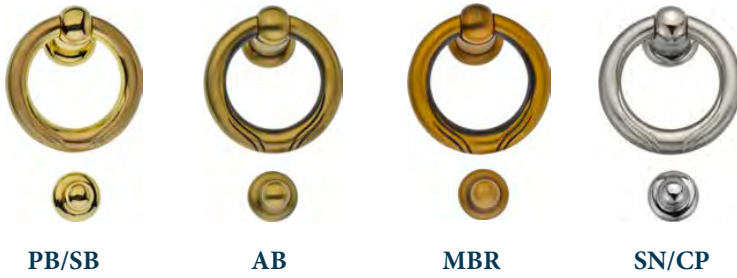

Кор. 24 шт.
Ctn. 24 pcs.

G 7



Новые молоточки G1 и G12 см. " Новинки" , стр. 124

G 8

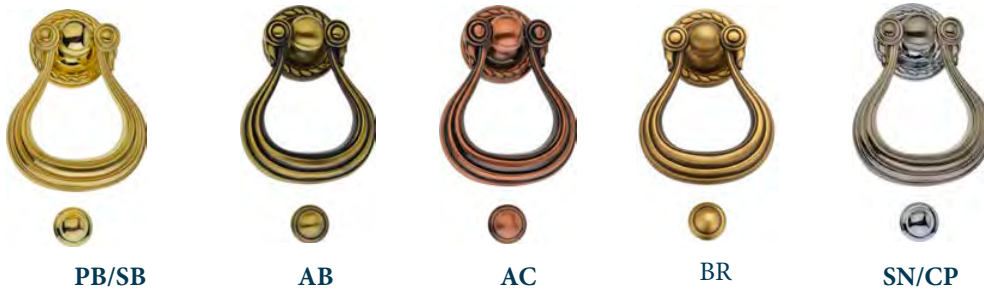

Глазки

Viewer

ZP-60

Для дверей толщиной 30-60 мм
(For doors with 30-55 mm thickness)

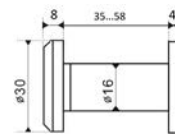

Кор. 200 шт. / Уп.20 шт.
Ctn. 200 pcs. / box 20 pcs.

ZP-100

Для дверей толщиной 60-100 мм
(For doors with 60-100 mm thickness)

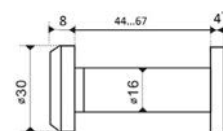

Кор. 200 шт. / Уп.20 шт.
Ctn. 200 pcs. / box 20 pcs.

ZP 30-60 Длина (size) 30-60 мм



БК

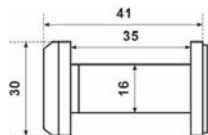

Кор. 200 шт. / Уп.20 шт.
Ctn. 200 pcs. / box 20 pcs.

ZP 60-100 Длина (size) 60-100 мм



БК

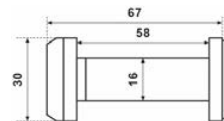

ZP 30-60 Блистер (Blister) Для дверей толщиной 34-55 мм (For doors with 34-55 mm thickness)



PB



AB



CP



PB



AB



CP



БК



SN



Кор. 200 шт. / Уп.10 шт.
Ctn. 200 pcs. / box 10 pcs.

ZP 60-100 Блистер (Blister) Для дверей толщиной 58-96 мм (For doors with 58-96 mm thickness)



БК



SN

Глазки DAMX Viewer DAMX



ZP 30-60 Длина (size) 30-60 мм



PB



AB



CP



БК



SN

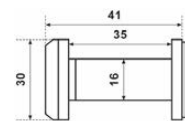

ZP 60-100 Длина (size) 60-100 мм



PB



AB



CP



БК



SN

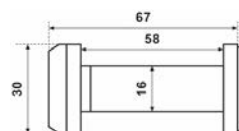

Кор. 200 шт. / Уп.20 шт.
Ctn. 200 pcs. / box 20 pcs.

Стопор дверной

Door stopper



ST 1

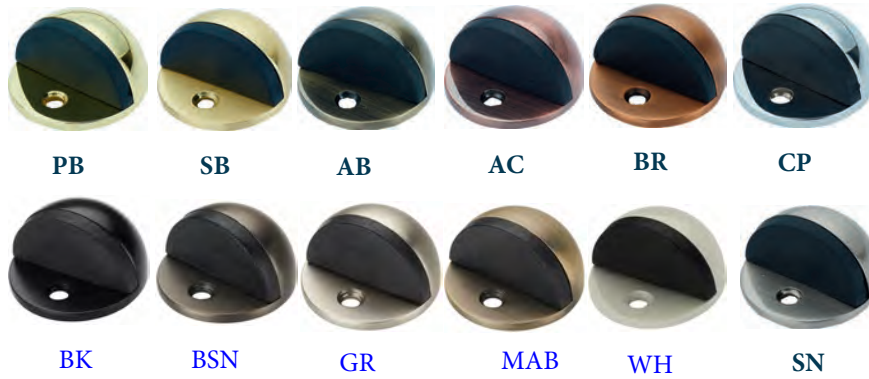

Новые цвета:
уже в наличии

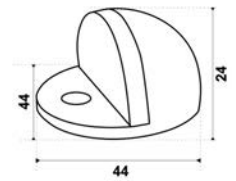

ST 2

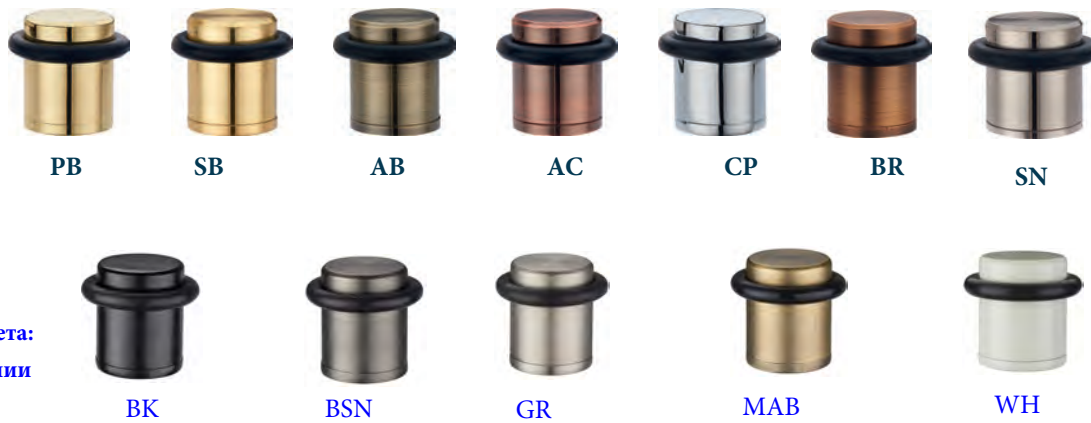

Новые цвета:
уже в наличии

Кор. 144 шт. / Уп.12 шт.
Ctn. 144 pcs. / box 12 pcs.

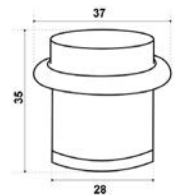

ST 2 L



Новые цвета:
уже в наличии



ST 3

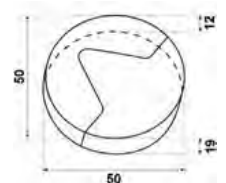
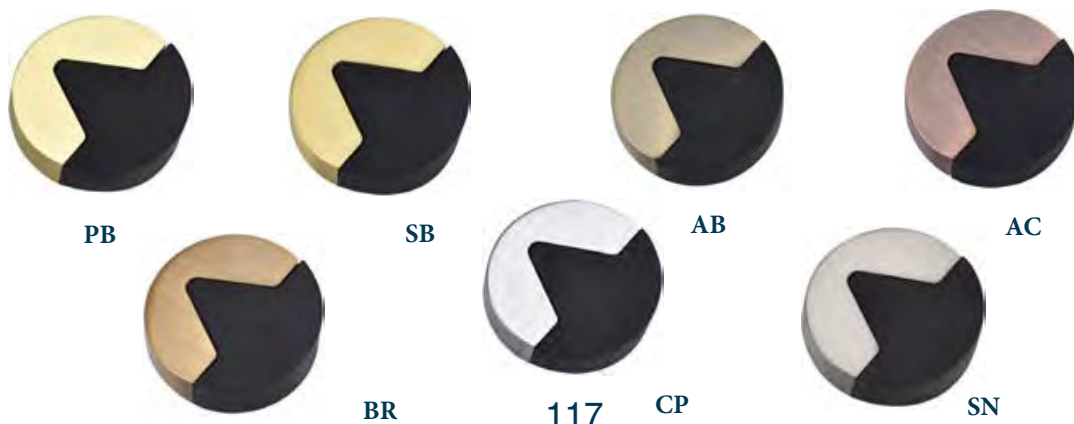

Кор. 60 шт. / Уп.6 шт.
Ctn. 60 pcs. / box 6 pcs.

Стопор дверной

Door stopper



ST 5

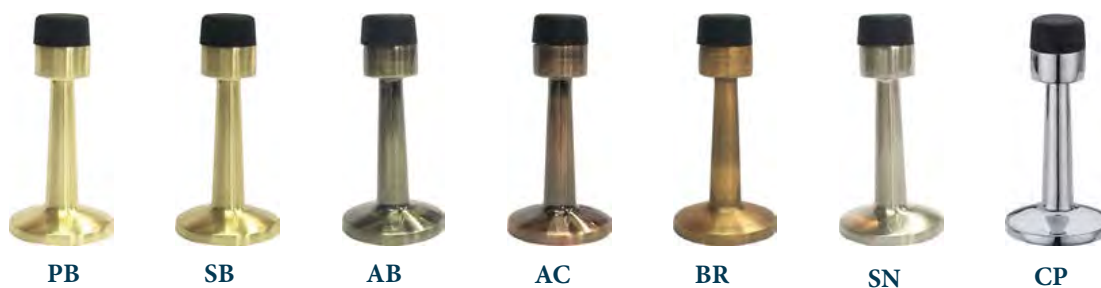

PB SB AB AC BR SN CP

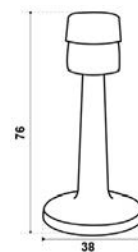

BK BSN GR MAB WH

Новые цвета:
уже в наличии



Кор. 60 шт. / Уп.6 шт.
Ctn. 60 pcs. / box 6 pcs.

ST6

NEW уже в наличии



PB SB AB AC BR MAB
GR BK CP WH BSN SN

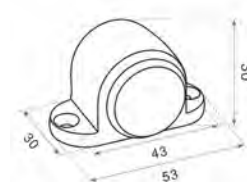

Кор. 144 шт. / Уп.12 шт.
Ctn. 144 pcs. / box 12 pcs.

ST6 L

NEW уже в наличии



PB SB AB AC BR MAB
GR BK CP WH BSN SN

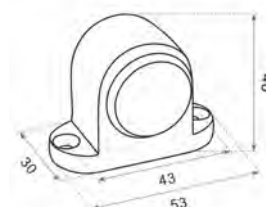

SM1



Новые цвета :
уже в наличии

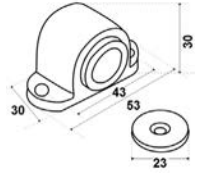

Кор. 144 шт. / Уп.12 шт.
Ctn. 144 pcs. / box 12 pcs.

SM1 L



Новые цвета:
уже в наличии

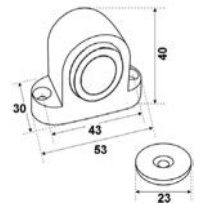

SM2



Новые цвета,
уже в наличии

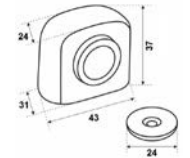

Кор. 144 шт. / Уп.12 шт.
Ctn. 144 pcs. / box 12 pcs.

SM5



Новые цвета:
уже в наличии

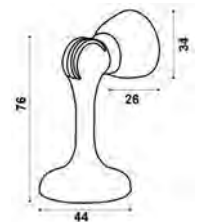

Кор. 60 шт. / Уп.6 шт.
Ctn. 60 pcs. / box 6 pcs.

Стопор дверной (магнитный)

Door stopper (magnetic)



SM6



PB SB AB AC CP BR SN



Кор. 60 шт. / Уп.6 шт.
Ctn. 60 pcs. / box 6 pcs.

Новые цвета :
уже в наличии



BK BSN GR MAB WH

SM7



PB SB AB



AC BR SN CP



Кор. 60 шт. / Уп.6 шт.
Ctn. 60 pcs. / box 6 pcs.



Ригель

Door bolt

D 14



PB SB AB AC BR SN

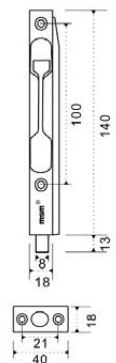

Кор. 144 шт. / Уп.12 шт.
Ctn. 144 pcs. / box 12 pcs.

K13

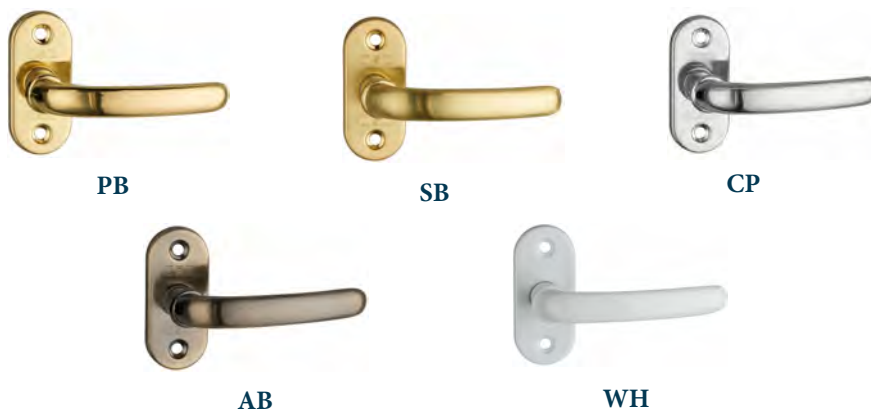

Кор. 120 шт. / Уп.10 шт.
Ctn. 120 pcs. / box 10 pcs.

K14

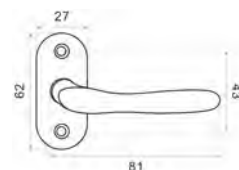
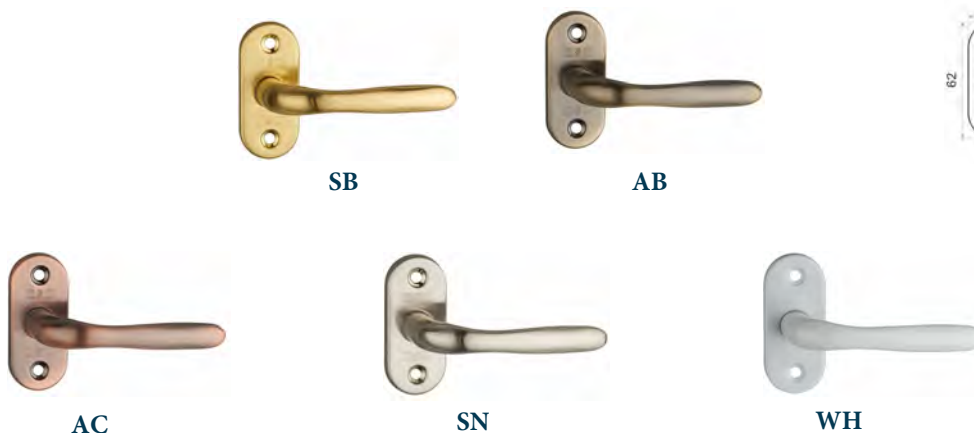

K23

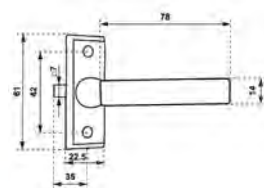
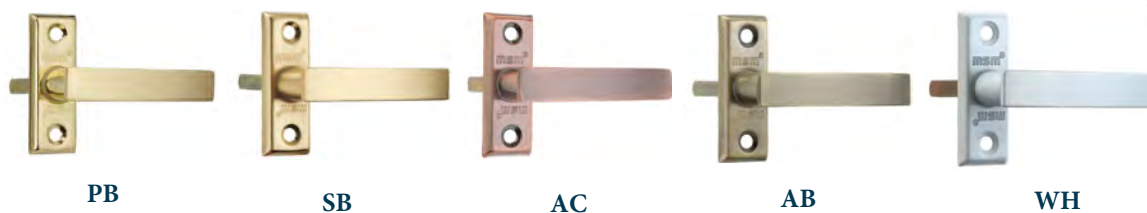

D 13

Оконный механизм

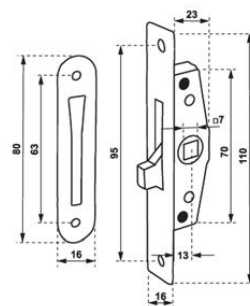
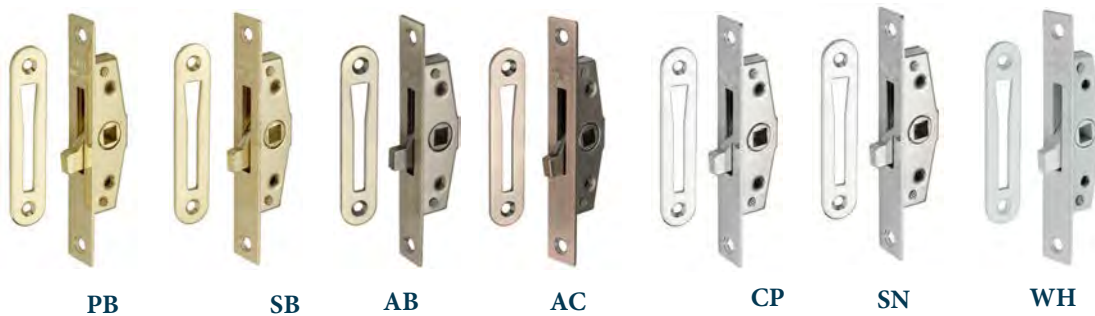

Кор. 200 шт. / Уп.20 шт.
Ctn. 200 pcs. / box 20 pcs.

RW1-K Накладка-фиксатор с ключом (Turn plate with key)

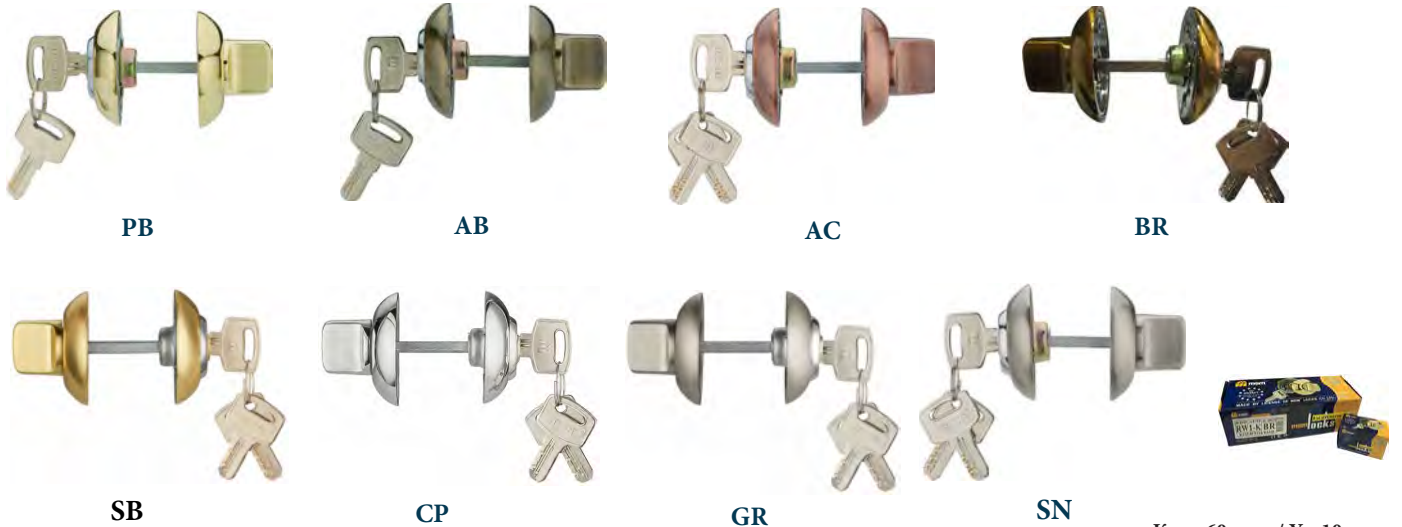

Кор. 60 шт. / Уп.10 шт.
Ctn. 60 pcs. / box 10 pcs.

M4-PL-3S

Стяжки для ручек на планке (Tie-screws for plate handles)



PB SB AB AC CP BR SN

Упак. 50 шт.
Ctn. 50 pcs.

Аналог M4, бывших ранее

Винт M5 L-55 мм screw M5



PB SN

Накладка овальная

Под цилиндр
(Oval cylinder plate)



PB

M4-PL2

Стяжки для ручек на планке
(Tie-screws for plate handles)



PB AB AC CP BR SN

Упак. 50 шт.
Ctn. 50 pcs.

M3-R2

Стяжки для ручек на круглой и квадратной накладке (Tie-screws for round handles)

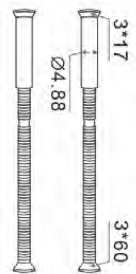

M3-R2

Упак. 50 шт.
Ctn. 50 pcs.

M4-PL-3-L

Стяжки для ручек на планке (Tie-screws for plate handles)



PB AB AC BR SN CP

U422



MAB



BSN



BSN

M6

Стяжки для ручек на планке (Tie-screws for plate handles)

Упак. 50 шт.
Ctn. 50 pcs.



PB



AB



AC BR SN



CP

A640

Материал ручек и розетки ЦАМ. Подпружиненные. Износостойкое многослойное покрытие. Крепление саморезами или стяжками.

Material of handles and escutcheons is zink. Resistant multi-layer plating. Can fixing with normal self-tapping screws or with security tie screws.



GR



AB



BSN



SN/CP

NC501

Комплект - 2 ручки, квадрат, саморезы, стяжки. Легкая установка.



PB



AB



BSN



SN



Кор. 12 шт.
ctn. 12 pcs.

Новинки : Ручки дверные «R»

Round plate handles «R»

CL5 CP

Замок почтовый
(Zip lock)



Наименование	L, мм
CL5-20 CP	20
CL5-25 CP	25
CL5-30 CP	30

CL5 BK

Замок почтовый
(Zip lock)



Кор. 120 шт. / Уп.12 шт.
Ctn. 120 pcs / box x 12 pcs.

W70

Сантехнический
(Sanitary)

Материал цилиндра - латунь.
(The material of cylinder brass)



Кор. 72 шт. / Уп.12 шт.
Ctn. 72 pcs. / box x 12 pcs.

W70-A

Сантехнический
(Sanitary)

Материал цилиндра - латунь.
(The material of cylinder brass)



Кор. 72 шт. / Уп.12 шт.
Ctn. 72 / box x 12 pcs.

W70-1

Сантехнический
(Sanitary)



Кор. 72 шт. / Уп.12 шт.
Ctn. 72 / box x 12 pcs.

G 1



PB/SB

MAB

BSN/GR

MBR

SN/CP

G12

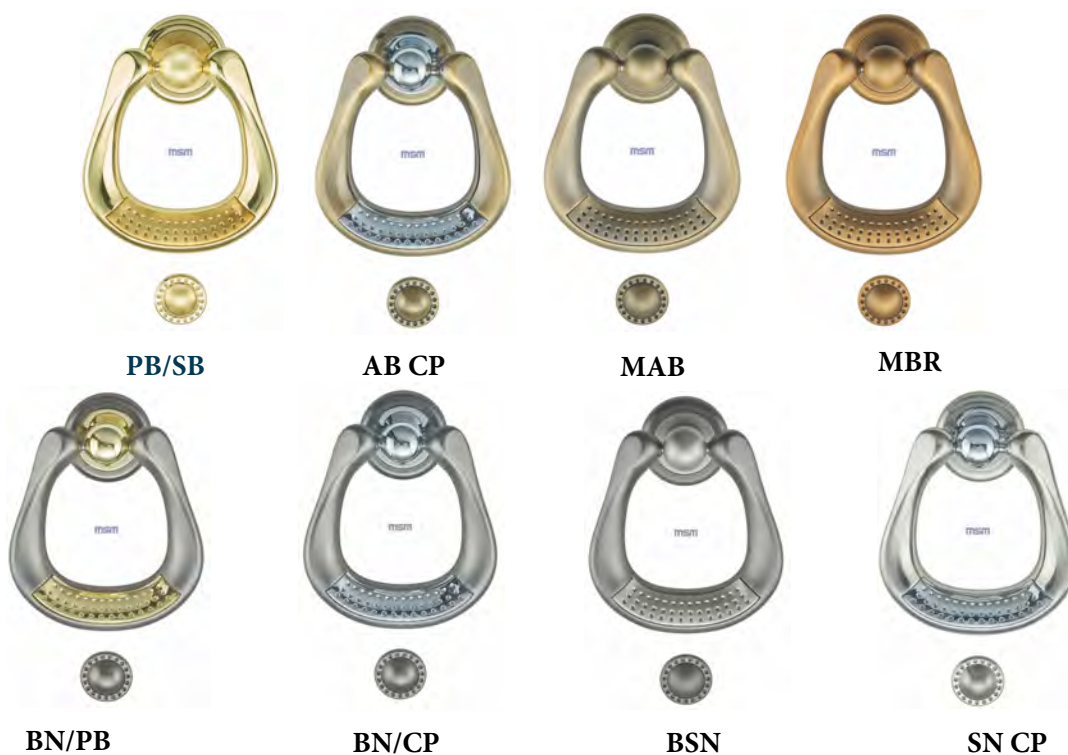

PB/SB

AB CP

MAB

MBR

BN/PB

BN/CP

BSN

SN CP



Коп. 24 шт.
Ctn. 24 pcs.

TS (3-6)

Переходник (с 6 на 8 мм)



RWD3-6

Накладка-фиксатор (Turn plate)

Квадрат 6x6 мм

Под мех-мы D45

RWD3-8

Квадрат 8x8 мм



AB

CP

SN



AB

CP

SN

Новые врезные замки добавлены на стр. 84-85 !

Материал ручек - алюминий, розеток - ЦАМ.
Подпружиненные. Износостойкое многослойное покрытие. Крепление саморезами или стяжками.

d = 54 мм

Material of handles is aluminum, Material of escutcheons is zink. Resistant multi-layer plating. Can fixing with normal self-tapping screws or with security tie screws.

T601

Приход ожидается



SB



AB - уже в наличии

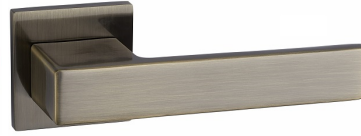

MAB - уже в наличии



GR - уже в наличии



BK



BSN



SN - уже в наличии

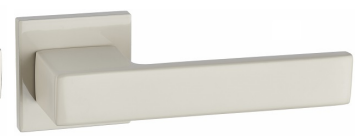

WH

T602



SB/PB - уже в наличии



AB/CP - уже в наличии



MAB/BK



GR/BSN - уже в наличии



BK/WH



BSN/CP - уже в наличии



SN/CP - уже в наличии



Кор. 18 шт.
ctn. 18 pcs.

T603



SB



AB



MAB



GR



BK



BSN



SN



WH

- пока нет наличии

DAMX Round plate handles «Т»

Материал ручек - алюминий, розеток - ЦАМ.
Подпружиненные. Износостойкое многослойное покрытие. Крепление саморезами или стяжками.

Material of handles is aluminum, Material of escutcheons is zink. Resistant multi-layer plating. Can fixing with normal self-tapping screws or with security tie screws.

d = 54 мм

Приход ожидается

T604



SB/PB

- пока нет наличии



AB/CP



MAB/BK



GR/BSN



BK/WH



BSN/CP



SN/CP



Кор. 18 шт.
ctn. 18 pcs.

T605



SB

- пока нет наличии



AB



MAB



GR



BK



BSN



SN



WH

- пока нет наличии

T606



SB



AB



MAB

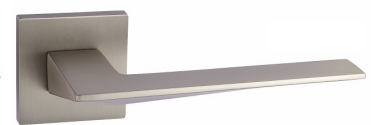

GR



BK



BSN



SN

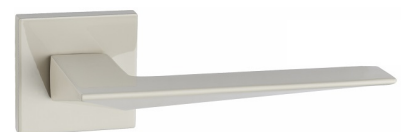

WH

- пока нет наличии

Материал ручек - алюминий, розеток - ЦАМ.
Подпружиненные. Износостойкое многослойное покрытие. Крепление саморезами или стяжками.

d = 54 мм

Material of handles is aluminum, Material of escutcheons is zink. Resistant multi-layer plating. Can fixing with normal self-tapping screws or with security tie screws.

T607

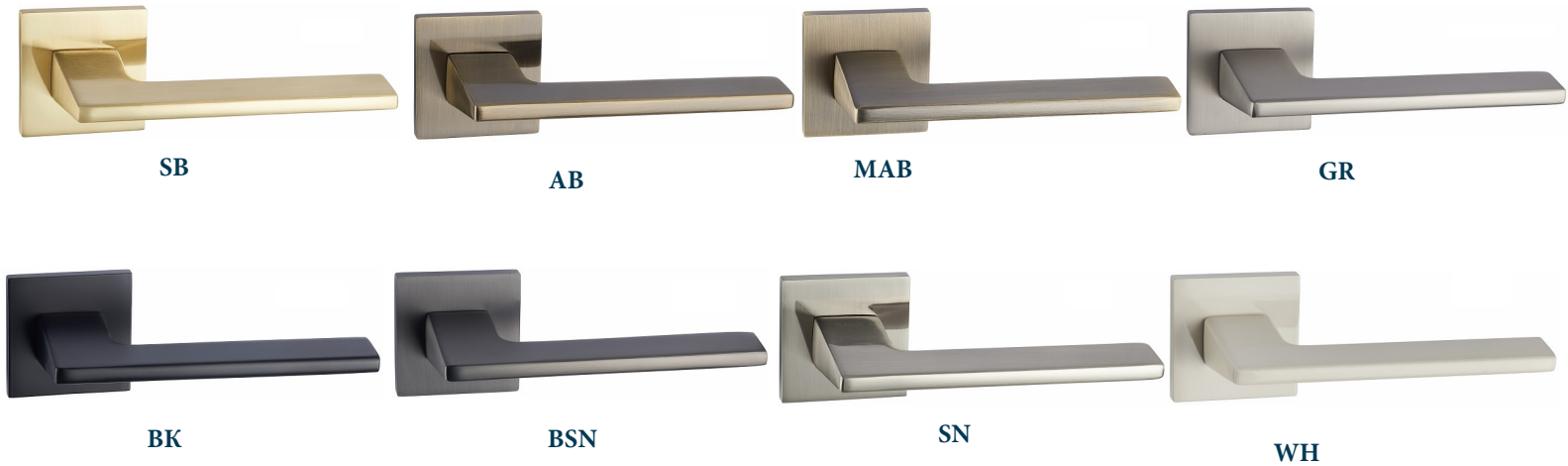

T608

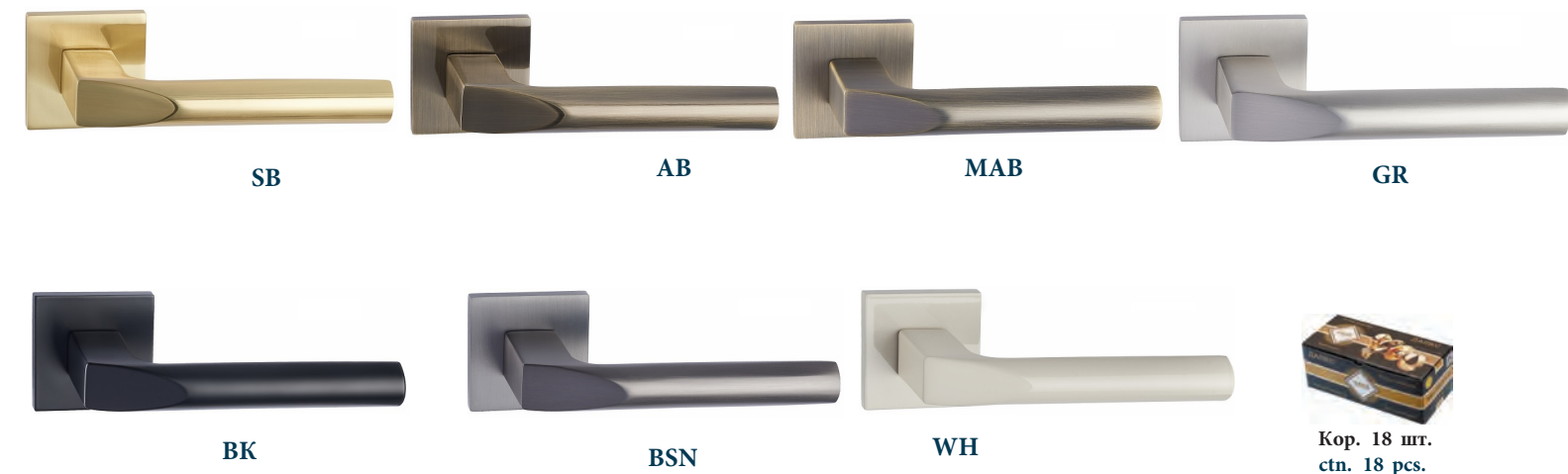

T609



Материал ручек - алюминий, розеток - ЦАМ.
Подпружиненные. Износостойкое многослойное покрытие. Крепление саморезами или стяжками.

Material of handles is aluminum, Material of escutcheons is zink. Resistant multi-layer plating. Can fixing with normal self-tapping screws or with security tie screws.

d = 54 мм

T1 Накладка под ключ



TW2 Накладка-фиксатор
Приход ожидается



U906

В наличии цвета :



Кор. 18 шт.
ctn. 18 pcs.

U908

В наличии цвета :



Материал ручек - алюминий, розеток - ЦАМ.
Подпружиненные. Износостойкое многослойное покрытие. Крепление саморезами или стяжками.

d = 54 мм

Material of handles is aluminum, Material of escutcheons is zink. Resistant multi-layer plating. Can fixing with normal self-tapping screws or with security tie screws.

U909

Приход ожидается

В наличии цвета :



БК

BSN

SN

WH

U910

Приход ожидается



Кор. 18 шт.
ctn. 18 pcs.

U911

Приход ожидается

В наличии цвета :



AB



MAB



BSN



SN

Литые ручки и планки. ЦАМ.
Износостойкое многослойное покрытие.
Крепление саморезами или стяжками.

Material of handles is zink. Resistant multi-layer plating.
Can fixing with normal self-tapping screws or with security tie screws.

405Z

продолжение
(continue)

К замкам ML72



AB



BSN



SN



Кор. 9 шт.
ctn. 9 pcs.

412Z

Габаритный размер (Total plate length) - 258 мм
К замкам ML72



AB



BSN



SN



Кор. 9 шт.
ctn. 9 pcs.

912Z

К замкам ML72



BSN



Кор. 9 шт.
ctn. 9 pcs.

912L-G

К замкам 85 мм



BSN

Винт М5-65

L-65 мм
screw M5-65

Приход ожидается



PB AB BR BSN SN

Винт М5-70

L-70 мм
screw M5-70

Приход ожидается



PB

SN

Заготовки ключей

N-1

простой ключ, для N-NW
(normal key, for N-NW)

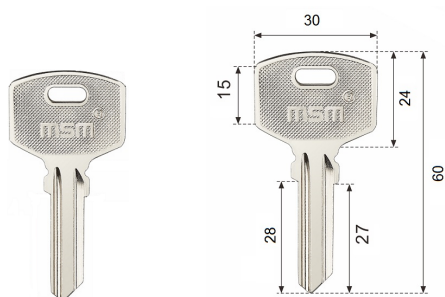

C-1

перфо ключ, для C-CW
квадратная головка, короткий кл.
(square head, short key)

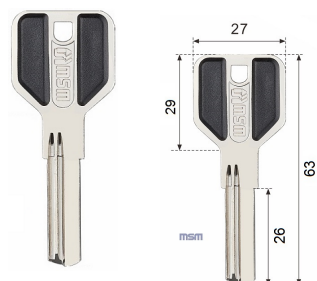

C-2

перфо ключ, для C-CW
квадратная головка, длинный кл.

Приход ожидается

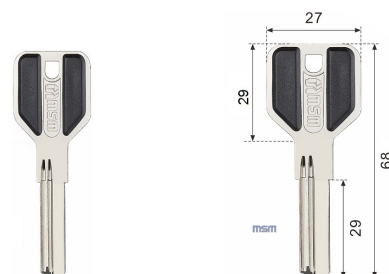

C-3

перфо ключ, для C-CW
овальная головка, короткий кл.



C-4

перфо ключ, для C-CW
овальная головка, длинный кл.

Приход ожидается



ML85-35

Приход ожидается



PВ



АВ

Наклейки

Прямоугольная
Sticker - rectangular

Круглая
Sticker - round



Пакеты

Сумки



38x60

Пакет-майка
Nylon bags



PLASTIC BAG
SIZE: 26x31

Пакет
Bag



NON WOVEN BAG

Ткань
Fabric bag



PP WOVEN BAG

Темная
Blue bag



PP WOVEN BAG

Светлая
Light bag

Подставка под цилиндры
Stand for cylinder

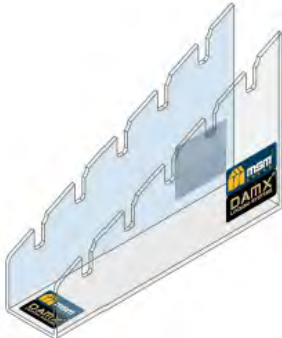

Каталог
Catalog



Подставка под замок
Stand for mortise lock



Ручка MSM
Pen



Подставка под ценник
Stand for the price tag

40x60



(на скотче)
(scotch tape)

Блокнот
Notepad



Стенды

Вращающиеся

Rotating stands



R WH/BL



R SL/BL



R RW/AW



R BW/RW



R AW/DW



R DW/AW



Z WH/BL



Z SL/BL



Z BW/RW



Y BW/RW



S BW/RW

С полками внутри
With shelves in side

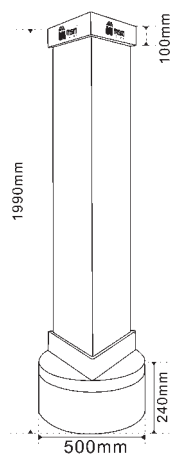

R

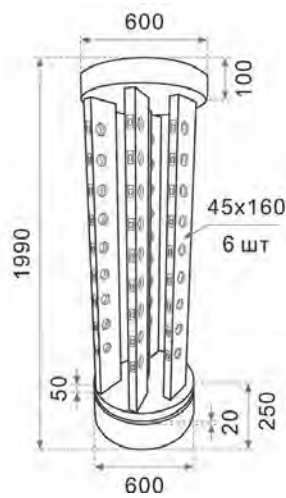

Z

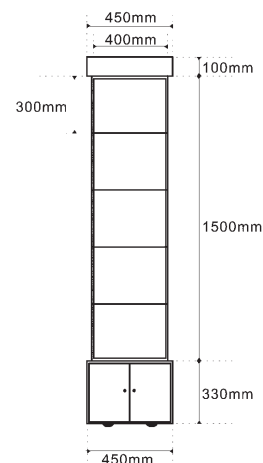

S



SPANISH QUALITY
NO.1 IN EUROPE

MADE BY MSM® LOCKS & HARDWARE CO.LTD.

Head office: MSM de Tous, 1240888 La Pobla de Vallbona, SPAIN.

Produced in PRC by MSM 3B/503, New Lucky House, Nathan Rd, HK.

Representation(Представительство): www.MSM.su